

Vol. 08 | April 2025

 SEISMIC  
ACADEMY

# Seismic

## A C A D E M Y

JOURNAL

# EARTHQUAKES

- Articles
- Recent Workshops
- Seismic Splendour

Seismic Academy Journal

An Initiative by **HILTI**  
Building Benchmarks for Industry and Academia

A **CE&CR** Production  
unmatched coverage

# SEISMIC ACADEMY

A forum for professionals, academicians, authorities and industry experts to interact and disseminate knowledge on various aspects of earthquake engineering with different stakeholders, with an intent to increase awareness and develop their expertise on the subject.

## OUR VISION

To make seismic academy as one source of information and use it for promotion of all seismic initiatives in our country.

## OUR ADVISORY BOARD



Er. Jayant Kumar  
Managing Director  
Hilti India Pvt. Ltd.



Dr. S. M. Ali  
Director General - Solar  
Energy Society of India



Er. Vinay Gupta  
Managing Director  
Tandon Consultants Pvt. Ltd.



Er. Alok Bhowmick  
Managing Director  
B&S Engg. Consultants Pvt. Ltd.



Dr. Amit Prashant  
Professor of Civil Engg.  
& Dean of Research & Devt.  
IIT Gandhinagar



Dr. Ajay Chourasia  
Chief Scientist and Head  
of Structural Engg. & 3D  
Concrete Printing Group  
CSIR-CBRI, Roorkee



Dr. Rajeev Goel  
Chief Scientist & Head  
Bridge Engg. & Strut. Div.  
CSIR-CRRI, New Delhi



Dr. Durgesh Rai  
Professor  
Dept. of Civil Engg.  
IIT - Kanpur



Er. Sangeeta Wij  
Managing Partner  
SD Engineering Consultants



Dr. Vasant Matsagar  
Dogra Chair Prof. & Head  
Dept. of Civil Engg.  
IIT Delhi



Er. Gangeswar Kawale  
Member  
MEP Engineers Associations



Dr. Harshavardhan Subbarao  
Chairman & Managing Director  
Construma Consultancy Pvt. Ltd.

“The information and views expressed in articles published in Seismic Academy Journal are those of the authors and Seismic Academy takes no responsibility regarding the same. No part of this publication may be reproduced by any means without prior written permission from Seismic Academy.”

IN THIS ISSUE - Total No. of Pages: 39 (Including Cover)

A **CE&CR** PRODUCTION

For further information, contact -

**Shounak Mitra**, Head - Codes & Approvals (Fastening), Hilti India Pvt. Ltd.

M: 9899732127 | E: support@theseismicacademy.com

# TABLE OF CONTENTS

## SEISMIC SPLENDOUR

<b>The Sales Force Tower Setting New Standards In San Francisco .....</b>	<b>04</b>
---	-----------

<b>Tokyo Skytree A Modern Marvel In TheHeart Of Tokyo .....</b>	<b>33</b>
---	-----------

## ARTICLES

<b>Draft IS 1893-PART 4 On Industrial Structures - A Review By Er. Bhavin Shah .....</b>	<b>08</b>
--	-----------

<b>Innovative Structural Integration in a Heritage - Style Restaurant By Dr. Rohit, Yudhishtir Saini &amp; Omendra Jakhar .....</b>	<b>14</b>
---	-----------

<b>Vertical Ground Motions and Its Effect on Structures By Dr. N. Subramanian .....</b>	<b>21</b>
---	-----------

## RECENT EARTHQUAKES

<b>Global Earthquake Report .....</b>	<b>17</b>
---------------------------------------	-----------

## RECENT WORKSHOPS

<b>Workshop Report On Earthquake Engineering And Structural Retrofit .....</b>	<b>30</b>
--	-----------

## THE SALES FORCE TOWER SETTING NEW STANDARDS IN SAN FRANCISCO



### INTRODUCTION

With the number of tall buildings in the United States and around the world increasing to an awe-inspiring race for height; they pose challenges to innovative structural engineering design, enhanced performance objectives, analyses, construction materials, and construction techniques. The structural innovations required to create this objective are expected to be scrutinized to provide requisite dynamic behavior and performances during extreme events, such as strong winds and shaking caused by earthquakes that originate from near and far seismic sources.

Standing at 326 meters height, Salesforce Tower, is one such 61 storey super-tall building that advances the state-of-the-art of high-rise seismic design through the implementation of a number of first-ever design and analysis methods that push limits and set new industry benchmarks.



## GEOMETRY AND SHAPE

The Salesforce Tower shows a unique obelisk design that becomes narrower toward its elevated height. The building design achieves both functional and aesthetic benefits and improves its seismic performance. The tapered design minimizes wind loads acting on the structure and reduces lateral forces on the building by limiting the wind-exposed surface area as elevation height increases. The building's stability increases through this geometric design because the lowered centre of gravity helps reduce overturning moments during seismic events.

The curved and tapering design of the building enables the smooth distribution of seismic forces throughout its entire structure. The sculptural crown on the building's top serves to reduce upper-level mass while improving dynamic response thus decreasing seismic forces during earthquakes.



## STRUCTURAL DESIGN AND SEISMIC RESILIENCE

Given the scale of Salesforce Tower, the calculated number of building occupants will far exceed the building code threshold of 5,000 people, triggering the building's consideration under Occupancy [or Risk] Category III (buildings requiring additional safety for wind and seismic demands), thus prompting new challenges for the engineering team.

A rigorous Performance-Based Seismic Design (PBSD) approach was implemented to allow for, quantify, and control desired building performance at an enhanced level compared to other commercial office buildings.

The project's structural engineer, Magnusson Klemencic Associates (MKA), brought to the project decades of leadership in seismic design in San Francisco. After assessing the more stringent Category III code-defined performance objective, and evaluating that intent and application relative to PBSD methodology, the design team targeted a reduction to 6% (from 10%) of the probability of collapse under a Maximum Considered Earthquake (MCE) ground shaking, consistent with ASCE 7 related to Occupancy Category III buildings.

The structural design of Salesforce Tower includes more stringent acceptance criteria for MCE shaking as explicit performance objectives, including the following:

- Reduced story drift
- Reduced coupling beam rotations
- Reduced tensile/compressive strains in shear walls
- Reduced shear demands on shear walls
- Risk Category II acceptance criterion was typically modified to be more stringent by applying a factor of 0.8

The structural system features a gravity load-resisting system with structural steel columns and floor framing supporting steel composite deck. The building's seismic force-resisting system comprises special reinforced concrete shear walls, 600 to 1200 millimetres thick, at the central elevator and stair core.

Although wind-loading conditions for the building are not trivial, wind tunnel testing confirmed that demand levels fell below seismic demands, and that occupant comfort standards would be met as judged against international standards. Hence, the lateral design of Salesforce Tower was driven by seismic loading conditions for three levels of ground shaking:

- Elastic performance targeted for service-level shaking (with a mean recurrence interval of 43 years)
- Moderate structural damage expected for design-level shaking (taken as two-thirds of code-defined MCE shaking)
- Collapse prevention, with a reduced probability of collapse consistent with Occupancy Category III, targeted for MCE shaking

The nonlinear time-history analyses used to confirm the structural response to MCE shaking employed two suites of 11 pairs of acceleration history. Two suites of ground motions were developed considering a Conditional Mean Spectra approach, targeting the first and second modes of vibration of the tower. This approach was deemed to more rigorously and appropriately test the building's design. The results of these 22 earthquake simulations were evaluated and compared against the targeted acceptance criteria. Where predicted demand levels exceeded acceptance criteria, design modifications were implemented. In particular, core wall thicknesses were tuned to reduce and control shear demands within acceptable limits at the tower's base and the location of a core setback.

The improved building performance was verified when all performance metrics including story drifts and coupling beam rotations and wall shear demands and vertical wall strains remained within acceptable parameters

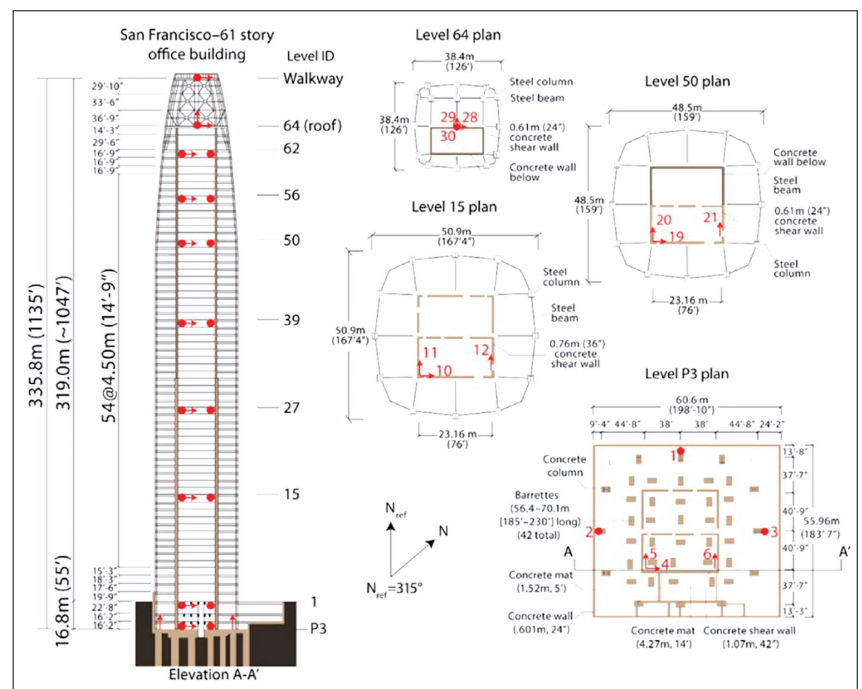

## FOUNDATION

The Salesforce Tower site is underlain with a complex soil stratum including fill, sand, San Francisco's "old bay clay," and weak bedrock. These geotechnical conditions are subject to potential liquefaction, lateral spreading, excessive settlement, and inadequate foundation support. Given the poor soils and the sheer weight of Salesforce Tower, supporting the building on anything but bedrock was not feasible. Gravity loading and overturning demands at the foundation level from MCE shaking dictated a piled-mat solution.

Two foundation systems were considered during the design process. As the depth to rock from existing grade was approximately 76 meters, and socketing into the rock would require drilling even deeper, the limits of available drilling equipment would be tested for a drilled shaft foundation. The alternate LBE, or "barrette" foundations, were not subject to the same depth limitations as the equipment used to excavate the shafts was a combination of a line-supported clam shell and hydro fraise. Ultimately, the LBE foundation system was selected as the most appropriate for the project.

An extensive analysis of the LBEs, considering extreme seismic demands, was performed. Reinforcing detailing was incorporated to resist the high tensile, flexural, and shear stresses imposed on the LBEs by MCE ground shaking. Confinement reinforcement was also specified in the upper zones of the LBEs where compressive demands were the highest. Two full-scale Osterberg Load Cells tests were conducted to confirm that the design parameters for the skin friction on the LBEs were appropriate.

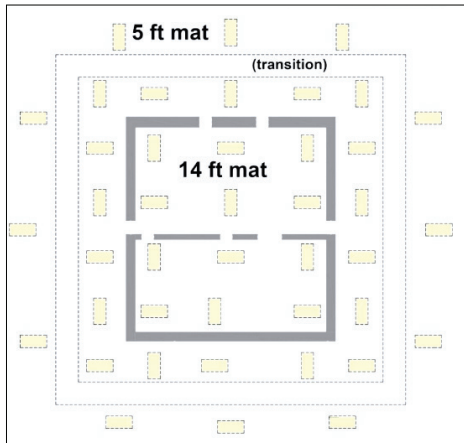

LBE Foundation System

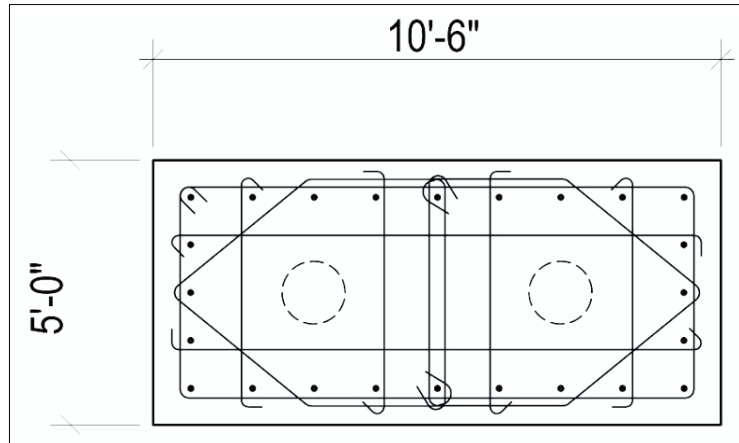

Typical LBE Rebar Detailing

The final foundation configuration for Salesforce Tower included 42 LBEs interconnected by a thick mat foundation to enforce compatibility (Figure 6). The mat varies in thickness from 4.3 metres at the core to 1.5 metres at the perimeter. LBEs extend into the underlying Franciscan bedrock, some reaching more than 91 metres feet below existing grade with rock-sockets of up to 21 metres.

### ADVANCED SSSI ANALYSIS

The Structure-Soil-Structure Interaction (SSSI) analysis made on Salesforce Tower created a groundbreaking evaluation of both the tower's seismic safety traits and its building-to-building connectivity. The analysis served as a vital step to verify that the tower's contact with neighbouring structures including the new Transbay Transit Center would remain unaffected during seismic occurrences. The SSSI analysis required extensive development of nonlinear computer models through CSI-Perform and LS-DYNA software which processed multiple seismic ground motions. The comprehensive assessment through this complex method verified that Salesforce Tower and the Transbay Transit Center operated satisfactorily.

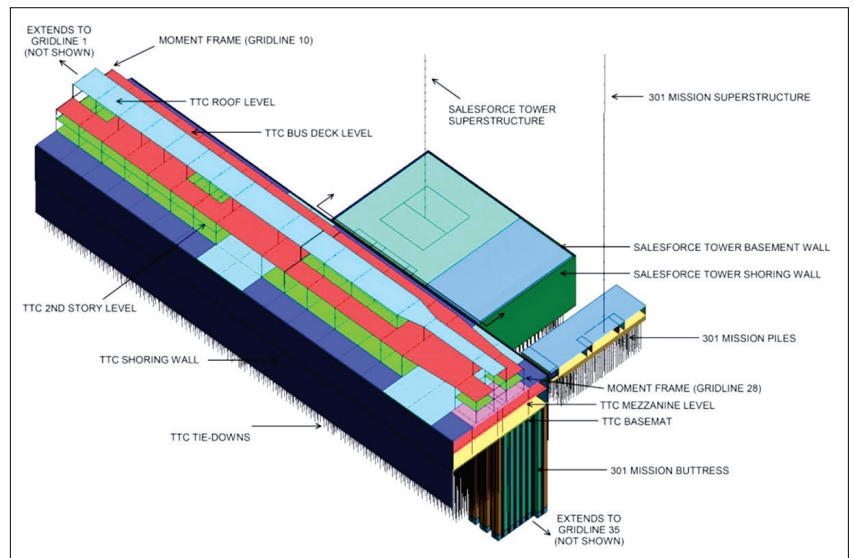

### CONCLUSION

Among the many innovative elements that make up Salesforce Tower, perhaps the most impressive is the new structural system created for the tower. The Structural Engineers designed a system that eliminates the need to use the exterior columns for anything other than carrying the weight of the floors to the foundation. The building uses a High-Performance Core in high-strength concrete and creates an extremely strong structural spine. This eliminated the need for dense structure at the exterior window line and allowed for the use of only three columns on each side of the building to create panoramic views for occupants.

### REFERENCES

- <https://journals.sagepub.com/doi/10.1193/112918EQS273M>
- <https://www.structuremag.org/article/salesforce-tower/>
- <https://www.structuralstalwarts.com/post/the-salesforce-tower>
- <https://wcee.nicee.org/wcee/article/17WCEE/2k-0001.pdf>
- <https://wiryantodotblog.wordpress.com/wp-content/uploads/2017/08/14-keynote-ron-klemencic.pdf>

# DRAFT IS 1893-PART 4 ON INDUSTRIAL STRUCTURES-A REVIEW



**Er. Bhavin Shah**  
 Founder & CEO  
 SQVe Consultants

## INTRODUCTION

Industrial structures often have irregular mass and stiffness distribution due to functional requirements, making them highly vulnerable to seismic forces. Failure or collapse of such structures may lead to severe hazards, endangering lives and may cause significant financial losses. Earthquake-resistant design is crucial to ensure life safety by preventing catastrophic failures and protecting workers and nearby communities. It also helps maintain operational continuity by minimizing structural damage and downtime, ensuring that critical industrial processes remain functional after an earthquake. Additionally, it safeguards expensive equipment, infrastructure and inventory, reducing economic losses.

In India, the earthquake-resistant design of industrial structures is governed by IS 1893 (Part 4). The first version of this code was introduced in 2005, followed by revisions in 2015 and 2024. Recently, the Bureau of Indian Standards (BIS) has circulated a draft code titled “CED 39 (27624)WC - Third Revision of IS 1893 (Part 4)” in month of February (2025) for comments.

This document shall be read in conjunction with the draft document of IS 1893 (Part 4).

## ALIGNMENT WITH GENERAL PROVISIONS

A key focus of the draft revision is its alignment with the anticipated 2025 versions of IS 1893 (Part 1) – General Provisions and IS 1893

(Part 5) – Buildings. This update aims to ensure consistency across Indian seismic design codes by integrating common definitions, earthquake hazard assessment methods, and general design criteria. The draft document frequently references IS 1893 (Part 1) & IS 1893 (Part 5). At certain places, the draft document is also referring to IS 13920.

*While preparing this article, the published versions of IS 1893 (Part 1): 2025, IS 1893 (Part 5): 2025, IS 13920 (Part 1): 2025 and IS 13920 (Part 5): 2025 were not available. As a result, changes related to these standards, along with potential practical difficulties, are not covered in this discussion. However, wherever possible, references have been made to the draft versions of IS 1893 (Part 1) and IS 1893 (Part 5) to provide relevant insights.*

## MAJOR CHANGES IN THE DRAFT DOCUMENT

The major changes in the draft revision are briefly summarized below. The categorization of industrial structures has been updated to align with IS 1893 (Part 1), ensuring consistency across seismic design codes. Importance factors have been adjusted to reflect revised earthquake hazard considerations. The Response Reduction Factor has been renamed as the Elastic Force Reduction Factor, with updated values for certain structural systems. Provisions for primary and secondary system interaction effects have been revised. The inclusion of In-Structure Response Spectra (ISRS) for design of secondary systems. Additionally, Operational and Functional Components (OFCs) have been defined along with their design procedures. The draft also introduces guidelines for estimating the natural period of stack-like structures. Revised provisions for chimneys and stacks are added.



*The above-mentioned changes, along with several other updates in the document, are outlined below. Additionally, potential practical difficulties associated with these changes are highlighted from the author's perspective.*

## REVISED CATEGORIZATION AND IMPORTANCE FACTORS

The draft revision updates the categorization of industrial structures to align with the upcoming IS 1893 (Part 1) – 2025, leading to corresponding adjustments in importance factors based on the revised earthquake hazard assessment. The draft classifies industrial structures into four categories, with Category 1 representing the most critical structures and Category 4 covering normal industrial buildings.

*As the category number increases, the relative importance of the structure decreases. However, the draft code assigns a uniform importance factor of 1.0 across all categories, irrespective of their criticality. This approach requires reconsideration, as it effectively diminishes the significance of the importance factor in seismic design.*

## QUICK SUMMARY FOR BASE SHEAR CALCULATION (PARA NO. 6)

- Revised Seismic hazard map to be considered as per IS 1893 (Part 1)
- Return period for strength design and serviceability check will be mentioned in IS 1893 (Part 1) for different categories of industrial structures.
- Design earthquake zone factor to be considered based on earthquake zone and return period from IS 1893 (Part 1)
- Elastic force reduction factor to be read from IS 1893 (Part 4)
- Importance factor to be considered from IS 1893 (Part 4)
- Site classes (A to E) for estimating normalized PSA from IS 1893 (Part 1)
- Elastic Horizontal PSA & elastic vertical PSA to be read from IS 1893 (Part 1)
- Multiplication coefficient for damping to be considered as per IS 1893 (Part 4)

## RELEVANT DESIGN STANDARDS

As per para 5.1.1 of the draft document, the design philosophy of the standard emphasizes maintaining the structural integrity of all industrial structures and components by ensuring forces and deformations remain within specified limits. Additionally, critical systems required post-earthquake, such as electrical supply, communication towers, and firefighting systems, must be designed to meet the prescribed force and deformation limits in relevant design standards.

*In this para, reference is given to the relevant design standards. The relevant design standards may be mentioned here for more clarity.*

## IN-STRUCTURE RESPONSE SPECTRA (ISRS)

The response spectra generated from the dynamic response of the structure at selected locations in a structure. In-structure response spectra are used for design of systems and components supported within a structure. As mentioned in para no. 5.1.3, equipment, mechanical systems, and machinery supported at various floor levels of an industrial structure will experience different motions at their support points. In such cases, obtaining In-Structure Response Spectra (ISRS) may be necessary for analysis and design of the equipment. Containers and vessels storing hazardous or toxic materials in the form of solids, liquids, or gases shall be analyzed using the applicable In-Structure Response Spectra (ISRS). For the generation of ISRS, para 9.7 is referred.

*In para no. 9.7, piping is also mentioned as one of the secondary system for generation of ISRS. It is necessary to clarify whether piping should also be considered a secondary system for the generation of In-Structure Response Spectra (ISRS). For equipment, also it may be clarified that generation of ISRS needed only for equipment storing hazardous or toxic material.*

As per para no. 9.7, there are two methods defined for generation of ISRS, i.e. response history method and direct spectra-to-spectra

method. Generally, method of direct spectra-to-spectra will be used in absence of availability of multiple ground motion records for a local region. As per para no. 9.7.2.2, obtained ISRS to be broadened by at least +15%. Requirement of frequency interval, smoothening & broadening peaks for ISRS are mentioned in para no. 9.7.3 and 9.7.4 respectively.

*The method outlined in the document can only be effectively implemented using software. To assist practicing engineers in interpreting and validating software results, the inclusion of worked-out practical examples along with clearly defined criteria would be beneficial.*

### CONSIDERATION OF OPERATIONAL SCENARIOS AND MASS IRREGULARITIES (PARA NO. 8.2.2)

Equipment supported on a structure can have multiple operational scenarios such as empty, partially full and full. These operational scenarios may result in mass irregularities that shall be duly accounted for. In case of multiple equipment supported on a structure, various possible combinations of operational conditions shall be considered.

*In industrial projects, three distinct conditions are generally considered: empty, operating, and testing. During the operating condition, the full capacity is typically assumed, while the partially full condition is often not considered. However, partially full conditions can lead to an increased number of load combinations, variations in seismic mass, and complexities in analysis. To address this, the document could provide further clarification by establishing specific criteria or mathematical limits defining when the partially full condition can be reasonably ignored.*

### NONLINEAR RESPONSE HISTORY ANALYSIS FOR CATEGORY 1 STRUCTURES

In para no. 8.2.5.1, it is mentioned that nonlinear response history analysis to be carried out for category 1 structures to verify the collapse mechanism. It is suggested that the specialist literature shall be referred.

*Nonlinear response history analysis is highly complex, involving numerous sensitive parameters that can significantly influence the results. Given this complexity, it is crucial to reference the appropriate specialist literature to ensure accurate modeling and interpretation. A well-curated list of relevant literature should be provided in the document, enabling engineers to refer to the correct sources. This will not only aid in conducting rigorous analyses but will also be invaluable in the proof-checking process, ensuring reliability and consistency in seismic design.*

### LOAD COMBINATIONS

As per para no. 8.3.1.1 (d), additional load combination is added for shear design of vertical members and for connections. In the load combination, earthquake force will be multiplied by the overstrength factor which is to be referred from IS 1893 (Part 5). In the earlier draft version of IS 1893 (Part 5), overstrength factor was not mentioned. Hopefully, the same will be mentioned in the published version of the document.

*With this new load combination, the connection design for industrial structures may be more critical as compared to the present codes.*

As per para no. 8.3.1.2 (c), for uplift check, dead load is multiplied by factor of 0.7.

*The same will result in more critical design for the uplift check as compared to the present code. Additionally, EEd is mentioned as design earthquake forces to be considered for strength design (para no. 8.3.1.1). For check of bearing pressure demands on soil and pile capacities, EEd should be based on serviceability check. The same may be mentioned or clarified in the document accordingly.*

It is also mentioned in para no. 8.3.1.2 (c) that increase in the net allowable bearing pressure on soils and pile capacities are not permitted. The same will result in higher demand for check of bearing pressure on soil or for pile capacities.

## DAMPING RATIO

Table 4 provides damping ratios for different materials, specifying 0.02 for steel and 0.05 for concrete.

*Since 2016, there has been ongoing debate regarding the variation in damping ratios in the current versions of IS 1893 (Part 1) and IS 1893 (Part 4). As a result, the multiplying factor for  $S_a/g$  exceeds 1.0 for industrial steel structures, whereas for normal steel buildings, it remains 1.0. This distinction does not appear to be a rational approach, as it creates inconsistencies in seismic design considerations. It is anticipated that the updated documents will provide further clarification and standardization on this issue.*

In the first part of Paragraph 9.4, a formula is provided to calculate the multiplying factor for determining the horizontal and vertical PSA for industrial structures when the damping value differs from 5%. In the second paragraph, the multiplying factor values are also referenced based on the time period. However, this paragraph refers to Table 5 for these values, while Table 5 actually pertains to the type of structural analysis.

*To avoid confusion, the correct table reference should be provided in the updated document. Also, it is essential to clarify how the two values of the multiplying factor—one derived from the formula and the other based on the time period—should be correlated. The document should provide explicit guidance on whether these factors are to be used independently, combined, or applied under specific conditions. Clear instructions will help avoid ambiguity and ensure consistent application in seismic analysis for industrial structures.*

As per Paragraph 9.4.1, for combined structures composed of more than one material, the damping ratio must be determined using well-established procedures.

*To avoid ambiguities in real projects and to serve as a reliable reference for proof-checking, the document should explicitly detail these established procedures. Providing a clear methodology will ensure consistency in seismic analysis and design, minimizing discrepancies in practical applications.*

## MODELLING STIFFNESS

As per para no. 9.2, deformation of the structure is to be checked using cracked section properties as per IS 1893 (Part 5).

*More clarity is needed on whether cracked section properties should be considered exclusively for deformation checks or also for strength design. If they are only required for deformation checks, a separate analytical model would be necessary—one for strength design and another for deformation verification.*

*For industrial structures, using cracked section properties for strength design may not be appropriate, as it increases the flexibility of the structure, leading to a reduced time period and consequently lower seismic forces. Unlike buildings, where empirical formulas for natural periods allow for the scaling of earthquake forces, industrial structures lack such provisions. Therefore, applying cracked section properties for strength design in industrial structures could lead to an underestimation of seismic forces, potentially compromising structural safety. More clarity on the same may be included in the updated document.*

## SOIL STRUCTURE INTERACTION (PARA NO. 9.5)

Soil-Structure Interaction (SSI) is not required when a structure is founded on rock (Class A or B as per IS 1893 (Part 1)). However, for all other soil types, SSI must be considered, accounting for two primary effects: the flexibility of the underlying soil strata and the inertia forces of the soil-foundation system. The methodology for SSI analysis will be outlined in IS 1893 (Part 1).

*In the draft version of IS 1893 (Part 1), the modulus of subgrade reaction (K) was specified to vary within a general range of 0.5K to 2.0K. Instead of defining a broad range, it would be more practical to specify discrete values, such as 0.5K, 1.0K, and 2.0K, to ensure consistency and ease of application in seismic design.*

*The document mentions that specialist literature may be referred to for Soil-Structure Interaction (SSI) analysis. However, to eliminate ambiguities in the selection of appropriate references, it would be beneficial to explicitly list the relevant literature within the document. This would provide a standardized reference framework, ensuring consistency in analysis and proof-checking while preventing misinterpretation or reliance on conflicting sources.*

The maximum reduction in base shear due to soil-structure interaction (SSI) and pile-soil-structure interaction (PSSI) shall not exceed 20 percent of the base shear obtained from a fixed-base analysis.

*To verify compliance with this limitation, separate analyses must be conducted—one with fixed-base support and another incorporating SSI effects.*

### INTERACTION EFFECTS BETWEEN PRIMARY AND SECONDARY SYSTEM

If a coupled analysis does not increase the response of key design parameters of the primary system by more than 10% compared to a decoupled analysis, then performing a coupled analysis is not required (para no. 9.6.4.3).

*The question arises that how to find out % difference between key design parameters without performing coupled analysis. Does it mean that coupled analysis is required for all structures or it might be possible to determine this directly from Fig. 1 of the draft document without performing a coupled analysis. To avoid ambiguities, the updated document may provide clear guidance on when a coupled analysis is mandatory and whether verification from Fig. 1 alone is sufficient.*

*To enhance clarity and facilitate practical implementation, it would be beneficial to include worked-out examples demonstrating the interaction effects between the primary and secondary systems under different scenarios outlined in the document. These examples would serve as valuable references for engineers, ensuring a better understanding of the requirements and aiding in accurate application in real projects.*

### INFILLED BRICK WALL

When masonry infill walls contribute to the in-plane stiffness of a structure, two different mathematical models are required for analysis. The first model includes the stiffness contribution of infill walls and is used to determine the natural period, drift, and base shear of the structure. The second model excludes the stiffness of infill walls and is used for estimating forces in the structural members. The base shear obtained from the second model to be enhanced to match the base shear value derived from the first model.

*As mentioned above, two separate models need to be generated for infilled brick wall.*

### OPERATIONAL AND FUNCTION COMPONENTS (OFCs)

OFCs are those components housed inside or attached to the industrial structure which are not part of the main load-resisting system and that are required for the function and operation of the industrial structure. As mentioned in para no. 12.9, there are two approaches for design of OFCs.

If the specified requirements mentioned in Para 12.9.1 are met, the Operational and Functional Components (OFCs) should be designed by considering the Interaction Effects between Primary and Secondary Systems as outlined in Para 9.6, along with the In-Structure Response Spectra (ISRS) as specified in Para 9.7.

OFCs which do not fall under the cases specified in para 12.9.1 then the same may be designed as per the procedure detailed out in IS 1893 (Part 1) for architectural elements and utilities.

*Including sample worked-out examples for OFCs will aid in proper implementation of requirements. These will help engineers interpret provisions, validate software results, and apply them appropriately in real projects.*

### CONCLUDING REMARKS

The third revision of IS 1893 (Part 4) introduces significant changes that will have a profound impact on the seismic design of industrial structures in India. The proposed modifications align this part of the standard with the updated versions of IS 1893 (Part 1) and IS 1893 (Part 5). Key updates such as the revision of importance factors, introduction of in-structure response spectra (ISRS), detailed considerations for operational and functional components (OFCs), SSI effects, etc. bring the code in line with evolving engineering knowledge and global best practices. Additionally, the revised provisions for soil-structure interaction (SSI) and the interaction effects between primary and secondary systems will significantly influence seismic response evaluations and design methodologies.

While these changes enhance the robustness of seismic design, their practical implementation requires further clarity. Concepts like ISRS, OFCs, and interaction effects between primary and secondary systems, SSI are relatively new

to the Indian code framework, and their correct application in real projects necessitates more illustrative worked-out examples. Detailed examples demonstrating these provisions, along with validation of software results, would be immensely beneficial for practicing engineers. Without such practical guidance, there is a risk of misinterpretation or improper application of the new provisions, which could impact the safety and reliability of industrial structures.

### WAY FORWARD

Given the far-reaching implications of these revisions, it is crucial for structural engineers, consultants, and industry professionals to actively review the draft document and share their feedback with the Bureau of Indian Standards (BIS) before the due date. Constructive inputs from experienced professionals will help refine the document, ensuring that the proposed revisions are both technically sound and practically feasible.

The ongoing revision of IS 1893 (Part 4) represents a significant step forward in strengthening earthquake-resistant design for industrial structures. However, successful adoption will depend on widespread industry participation, practical interpretation of the provisions, and continuous learning through real project applications.



## 12<sup>TH</sup> INTERNATIONAL CONFERENCE BEHAVIOUR OF STEEL STRUCTURES IN SEISMIC AREAS

September 7-9, 2026 | IIT Delhi, India

**Organized by**  
Indian Institute of Technology Delhi

**In Association with**  
Indian Institute of Technology Roorkee  
University of Naples "FEDERICO II", Italy  
University of Salerno, Italy

**Honorary Chairman**  
Federico M. Mazzolani

**Conference Chairmen**  
Dipti Ranjan Sahoo  
Raffaele Landolfo

**Scientific Committee Chairman**  
Vincenzo Piluso

<http://stessa2026.iitd.ac.in>

# INNOVATIVE STRUCTURAL INTEGRATION IN A HERITAGE - STYLE RESTAURANT



**Dr. Rohit**  
Founder & Project Head  
TeXel Consulting Engineers



**Yudhishtir Saini**  
Project Coordinator  
TeXel Consulting Engineers



**Omendra Jakhar**  
Structural Designer  
TeXel Consulting Engineers

## INTRODUCTION

Contemporary architectural trends often blend historical aesthetics with modern materials, creating structures that honour cultural heritage while meeting functional demands. This case study explores the structural design of a single-story heritage-style restaurant that uniquely integrates three materials: Mild steel, Stone, and Reinforced Cement Concrete. The project posed significant challenges due to the contrasting mechanical properties of the materials, particularly in managing connections and load transfer mechanisms. The structural complexity arose from material incompatibilities, necessitating innovative

engineering solutions. This study highlights the challenges, methodologies, and outcomes, the successful implementation underscores the viability of hybrid material systems in heritage conservation while addressing modern safety standards.

## PROJECT OVERVIEW

The restaurant is designed with a ground-floor layout that pays homage to heritage architectural styles while incorporating modern structural systems. Key structural elements include:

**Outer Columns:** Fabricated from mild steel having High ductility, tensile strength, and weldability. Susceptible to corrosion and fire, Efficient in resisting vertical and lateral loads but prone to deflection under roof loads, complicating integration with rigid glass panels.

**Inner Columns:** Constructed using natural stone, selected for its aesthetic appeal, but noted for its limited performance under lateral forces and difficulty in establishing moment-resistant connections.

**Beams and Deck Slab:** Executed in RCC, chosen for its overall strength, durability, and ease of integration with other materials.

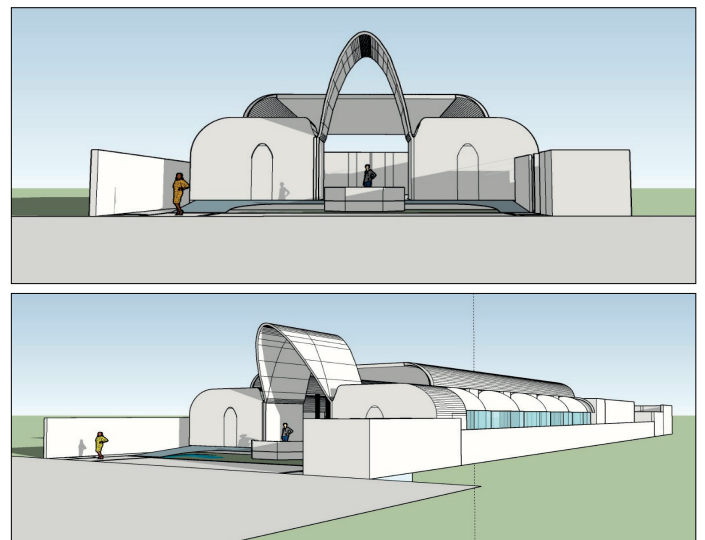

Figure 1: 3D Model of Structure

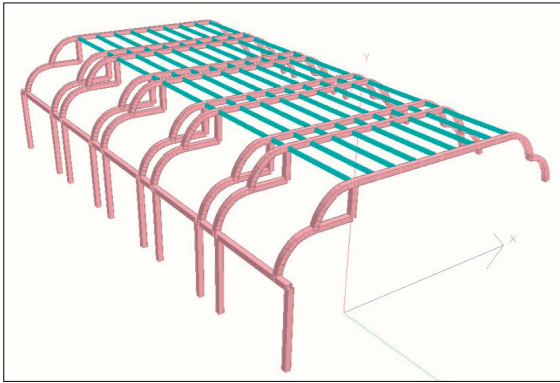

Figure 2: 3D Model created for Analysis

**CHALLENGES AND SOLUTIONS**

1. The primary challenge was to develop an efficient connection system that could accommodate the different behaviours of RCC, Stone and Mild Steel. Given that stone columns are not well-suited to resist lateral forces. To address this, our design team engineered an RCC pedestal with an integrated shear key at the base of the stone columns. Hilti

fasteners were used to secure the stone columns to the pedestal, ensuring a robust connection without imposing additional bending moments. This detail allowed the stone to function primarily in axial compression while isolating it from the lateral and moment forces transferred from the adjoining structural system.

2. Creating a simply supported connection that avoids transferring moments to the stone columns was essential, particularly to preserve the integrity and performance of the natural stone elements.

We implemented a pin connection at the beam-to-column interface for the steel elements. This approach ensured that the beam functioned as simply supported, minimizing moment transfer. By decoupling the beam from the stone column, we maintained the intended structural behaviour of each material while achieving the desired aesthetic outcome.

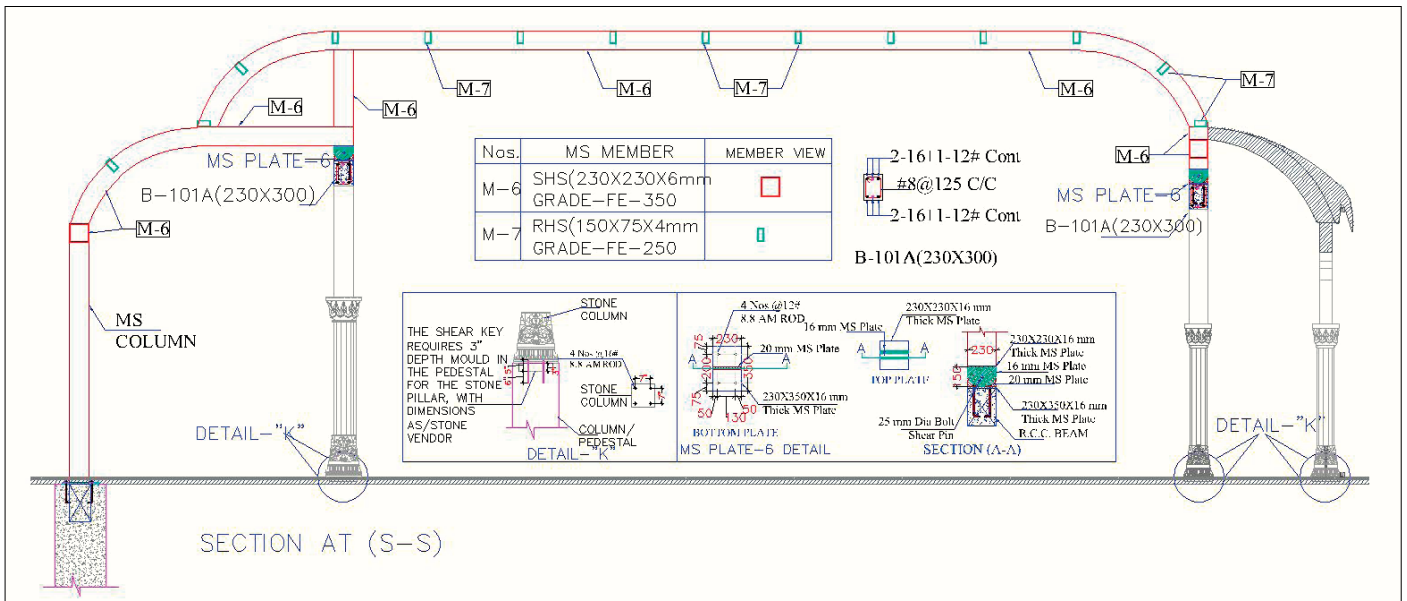

Figure 3: Structural Drawing

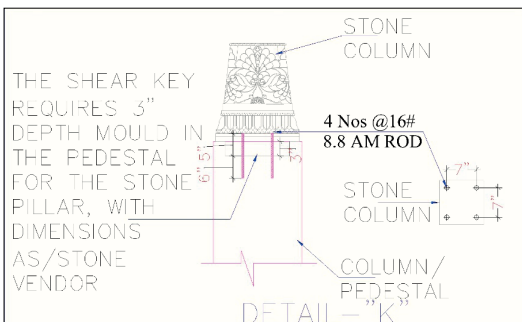

Figure 4: Pedestal to Stone Column Connection

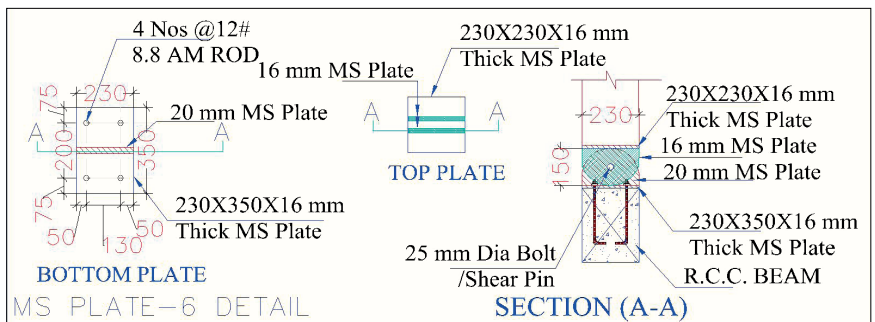

Figure 5: Stone Column- RCC Beam and Steel Column Connection

### 3. Achieving a Secure Connection for the Half Dome to MS Members Without Compromising the Stone Element

Another critical challenge encountered was the safe and effective integration of the half-dome structure with the mild steel (MS) support members, especially at points of intersection with stone. Due to the brittle nature of stone, conventional anchoring techniques such as drilling or bolting posed a high risk of inducing cracks or failure due to its size at junction. To address this, an interlocking joint system was developed. The geometry of the stone elements was precisely modified to form a notched profile, which allowed for a snug fit around the MS members. This interlocking mechanism not only eliminated the need for intrusive mechanical fasteners but also enabled the transfer of forces through direct bearing and geometric confinement. The solution ensured both structural stability and material preservation while respecting the aesthetic language of heritage architecture.

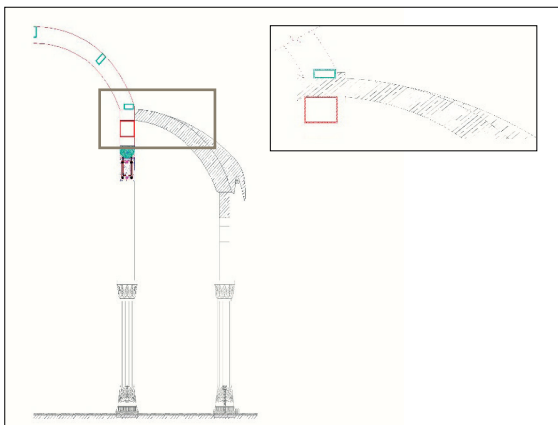

Figure 6: Interlocking for Half Dome

The multi-material integration in this project required a rigorous analysis of material behaviour and connection details. RCC proved reliable in accommodating complex load distributions and deflection criteria, while the inherent limitations of stone were mitigated through innovative use of RCC pedestals and mechanical fasteners. The mild steel, with its superior ductility, facilitated the creation of unique column profiles that complemented the heritage aesthetics of the restaurant. Our solutions not only addressed structural challenges but also maintained the visual integrity of the design.

Additionally, the project served as an opportunity to test novel connection strategies that may be applicable to other heritage-style structures. The use of Hilti fasteners and shear keys represents a promising approach to integrating stone with modern construction materials, offering potential pathways for future research and development in multi-material construction.

### CONCLUSION

This case study demonstrates that with careful design, analysis, and innovation, the integration of disparate materials can yield a structurally sound and aesthetically appealing building. Our tailored solutions addressed the challenges posed by the different structural behaviours of RCC, stone, and mild steel. Although the project was not large in scale, the techniques developed herein contribute to best practices in multi-material structural integration and open avenues for future research in heritage-inspired construction.

## DID YOU KNOW?

**Earthquakes Can Shorten the Length of a Day** Large earthquakes can actually alter the Earth's rotation and slightly shorten the length of a day. This happens because the redistribution of mass during a massive quake affects the planet's moment of inertia — much like a figure skater pulling in their arms to spin faster.

**Example:** The 2011 Japan earthquake (magnitude 9.1) is believed to have shortened Earth's day by about 1.8 microseconds and shifted the planet's axis by approximately 17 cm.

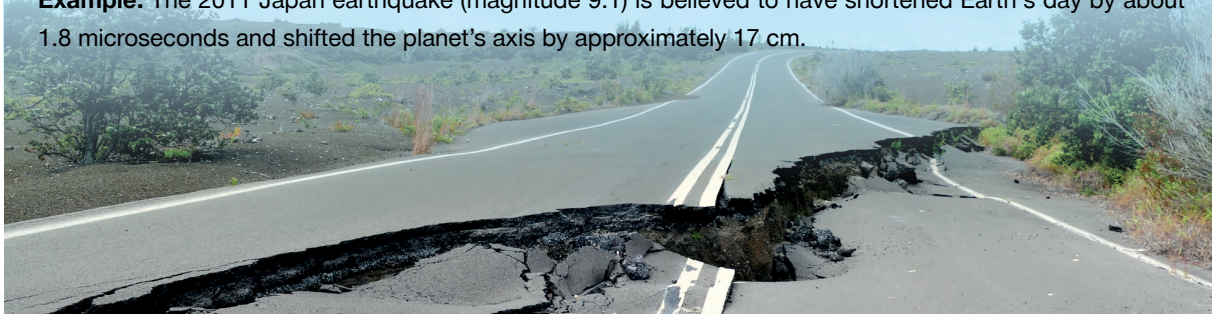





# GLOBAL EARTHQUAKE REPORT

## NEW ZEALAND

**Date:** April 30, 2025

**Magnitude:** 6.2

**Epicenter:** Off the west coast, approx. 300 km southwest of Invercargill

**Impact:** No damage or injuries reported. No tsunami warning issued.

## ISTANBUL, TURKEY

**Date:** April 23, 2025

**Magnitude:** 6.2

**Impact:** Over 359 injuries, structural damage to 2,900+ buildings, and 260+ aftershocks. A minor tsunami was also reported.

**Epicenter:** Sea of Marmara, near Silivri



Image Source: <https://www.khaleejtimes.com/world/mena/istanbul-hit-by-62-magnitude-earthquake>

## JAPAN (MULTIPLE EVENTS IN APRIL 2025)

### 1. TOKARA ISLANDS – APRIL 21, 2025

**Date & Time:** April 21, 2025, 1:47 PM JST

**Location:** Near Tokara Islands, Kagoshima Prefecture, Japan

**Magnitude:** 3.2

**Depth:** 69 km

**Epicenter:** Offshore near Tokara Islands

**Seismic Intensity:** Light tremors felt

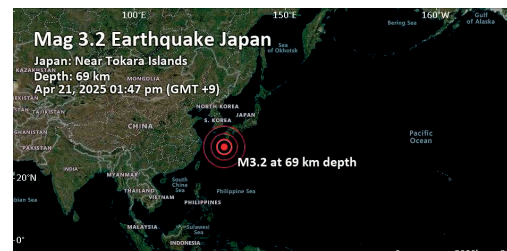

Image Source: <https://www.volcanodiscovery.com/earthquakes/quake-info/21694905/mag3quake-Apr-21-2025-Japan-Near-Tokara-Islands.html>

### 2. NAGANO PREFECTURE – APRIL 19, 2025

**Date & Time:** April 19, 2025, 1:02 AM JST

**Location:** Northern Nagano Prefecture, Japan

**Magnitude:** 4.1

**Depth:** 10 km

**Epicenter:** Northern Nagano

**Seismic Intensity:** 4 on Japan's seismic scale

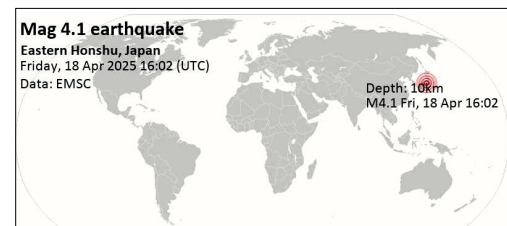

Image Source: <https://www.volcanodiscovery.com/earthquakes/quake-info/21686544/quake-felt-Apr-18-2025-Near-Matsumoto-Nagano-Japan.html>

### 3. NAGANO PREFECTURE – APRIL 18, 2025

**Date & Time:** April 18, 2025, 8:19 PM JST

**Location:** Northern Nagano Prefecture, Japan

**Magnitude:** 5.0

**Depth:** 10 km

**Epicenter:** Northern Nagano

**Seismic Intensity:** Lower 5 on Japan's seismic scale

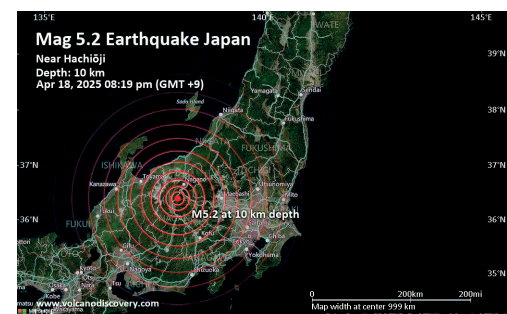

Image Source: <https://www.volcanodiscovery.com/earthquakes/quake-info/21685802/quake-felt-Apr-18-2025-Near-Nagano-Nagano-Japan.html>

## HIMACHAL PRADESH, INDIA (MANDI)

**Date & Time:** April 18, 2025, around 10:12 AM IST

**Location:** Mandi District, Himachal Pradesh, India

**Magnitude:** 3.4

**Depth:** 10 km

**Epicenter:** Near Mandi, Himachal Pradesh

**Seismic Intensity:** Moderate tremors felt across Mandi



Image Source: <https://www.livemint.com/news/india/himachal-pradesh-earthquake-3-4-magnitude-quake-shakes-mandi-11736263883010.html>

## NEW ZEALAND (RIVERTON COAST)

**Date & Time:** April 18, 2025, early morning local time

**Location:** Off Riverton Coast, South Island, New Zealand

**Magnitude:** 6.8

**Depth:** 10 km

**Epicenter:** Offshore, southwest of South Island

**Seismic Intensity:** Strong shaking felt across Southland and Otago regions



Image Source: <https://www.travelandtourworld.com/news/article/magnitude-6-8-earthquake-strikes-new-zealands-riverton-coast-no-tsunami-warning-issued/>

## SAN DIEGO, USA

**Date:** April 14, 2025

**Magnitude:** 5.2

**Impact:** No injuries or structural damage. Notable animal alert behavior at San Diego Zoo during quake.

**Epicenter:** Near Julian, California

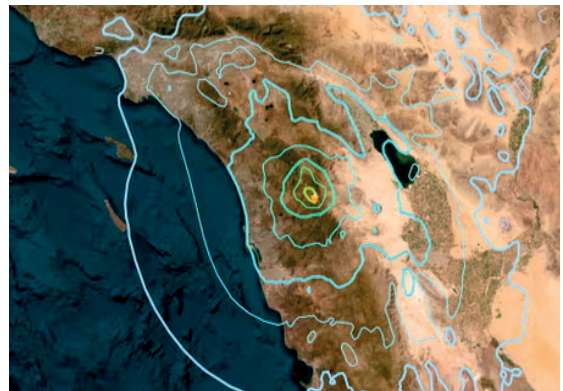

Image Source: <https://www.theguardian.com/us-news/2025/apr/14/san-diego-julian-earthquake>

## INDIA-PAKISTAN BORDER REGION

**Date & Time:** April 12, 2025, around 1:00 PM IST

**Location:** Jammu & Kashmir, India, and northern Pakistan

**Magnitude:** 5.8

**Depth:** 10 km

**Epicenter:** In Pakistan

**Seismic Intensity:** Moderate tremors felt across Kashmir valley

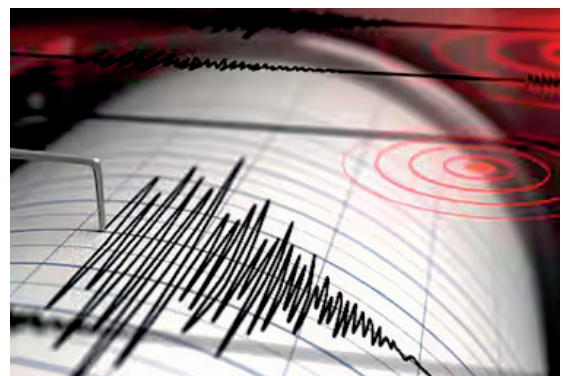

Image Source: <https://www.india.com/news/india/breaking-earthquake-of-5-8-magnitude-strikes-pakistan-tremors-felt-in-jammu-and-kashmir-7750573/>

## AGARTALA, INDIA

**Date:** April 11, 2025

**Magnitude:** 4.3

**Impact:** Minor tremors felt. No significant damage or injuries reported.

**Epicenter:** 15 km northwest of Agartala

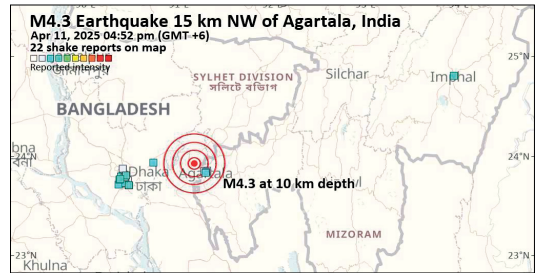

Image Source: <https://allquakes.com/earthquakes/quake-info/21663602/quake-felt-Apr-11-2025-Near-Bhatar-Dhaka-Division-Bangladesh.html>

## MYANMAR

**Date:** March 28, 2025

**Magnitude:** 7.7 – 7.9

**Impact:** Over 5,400 fatalities, 11,400 injuries, and significant damage across Myanmar, Thailand, China, and Vietnam.

**Epicenter:** Sagaing Region, near Mandalay



Image Source: <https://www.euronews.com/2025/03/28/strong-77-earthquake-strikes-myanmar-and-neighbouring-thailand>

## INDIA (DELHI-NCR)

**Date & Time:** February 17, 2025, 5:36 AM IST

**Location:** Delhi-NCR (New Delhi, Noida, Ghaziabad, Gurgaon)

**Magnitude:** 4.0

**Depth:** 5 km

**Epicenter:** Estimated around 14 km from New Delhi

**Seismic Intensity:** Moderate tremors, early morning shock

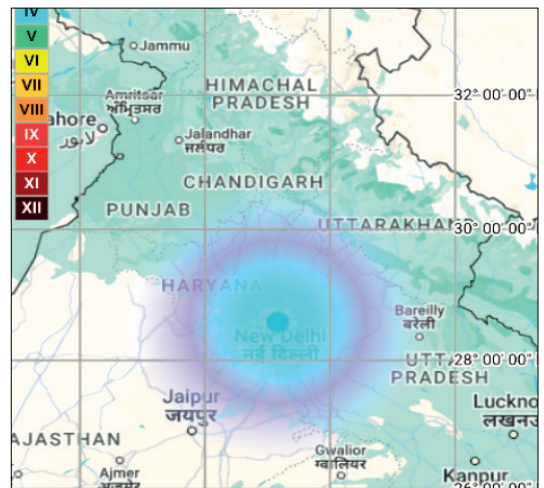

Image Source: <https://www.ndtv.com/delhi-news/delhi-earthquake-today-live-updates-4-0-magnitude-earthquake-hits-capital-tremors-felt-across-north-india-earthquake-today-7727335>

## CARIBBEAN SEA (NEAR CAYMAN ISLANDS)

**Date & Time:** February 8, 2025, 6:23 PM EST

**Location:** South-southwest of George Town, Cayman Islands

**Magnitude:** 7.6

**Depth:** 10 km

**Epicenter:** 209 km south-southwest of George Town, Cayman Islands

**Seismic Intensity:** Strong shaking felt across parts of the Caribbean



Image Source: <https://www.weathernationtv.com/news/strong-earthquake-in-western-caribbean-saturday-night>

## GREECE (SANTORINI)

**Date & Time:** February 5–7, 2025 (most significant quake: February 5, evening)

**Location:** Santorini, Cyclades Islands, Aegean Sea

**Magnitude:** 5.2 (strongest recorded); swarm included smaller quakes over 4.0

**Depth:** Not specified

**Epicenter:** Near Santorini, in the Hellenic Volcanic Arc

**Seismic Intensity:** Ongoing swarm of tremors, with heightened seismicity for over a week

## SANTORINI, GREECE (AFTERSHOCK EVENTS)

**Date & Time:** February 5 –7, 2025

**Location:** Santorini, Cyclades Islands, Aegean Sea

**Magnitude:** 5.2

**Depth:** Not specified

**Epicenter:** Near Santorini, in the Hellenic Volcanic Arc

**Seismic Intensity:** Ongoing tremor swarm

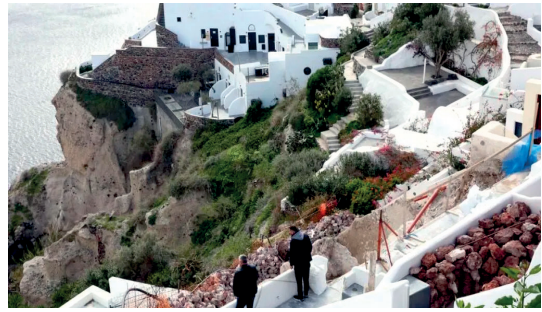

Image Source: <https://www.bbc.com/news/articles/cp8qpn2p795o>

## WESTERN NEPAL (DAILEKH DISTRICT)

**Date & Time:** February 4, 2025, at 5:20 PM local time

**Location:** Dailekh District, Karnali Pradesh, Western Nepal

**Magnitude:** 4.4

**Depth:** Not specified

**Epicenter:** Tolijaisi, Dailekh District

**Seismic Intensity:** Light to moderate tremors felt in neighboring districts



Image Source: [https://www.dailyexcelsior.com/mild-earthquake-hits-western-nepal/#google\\_vignette](https://www.dailyexcelsior.com/mild-earthquake-hits-western-nepal/#google_vignette)

## TIBET, CHINA

**Date:** January 7, 2025

**Magnitude:** 7.1

**Impact:** 126–400 fatalities, 350+ injuries, with damage reaching Nepal and northern India.

**Epicenter:** Tingri County, Shigatse

## REFERENCES:

- <https://www.hindustantimes.com/india-news/earthquake-of-magnitude-3-4-jolts-himachal-pradeshs-mandi-101744520220923.html>
- <https://www.prabhatkhabar.com/national/earthquake-tremors-felt-from-india-to-pakistan-people-panic>
- <https://www.livemint.com/news/world/earthquake-today-magnitude-6-8-quake-rocks-new-zealands-riverton-coast-11742869869630.html>
- <https://bengali.news18.com/photogallery/international/earthquake-strong-earthquake-tremors-shook-japan-twice-today-causing-panic-among-people-world-news-snk-ws-ab-2086171.html>
- <https://news.abplive.com/cities/massive-earthquake-tremor-shakes-delhi-ncr-1751901>
- <https://www.indiatv.in/world/around-the-world/7-6-magnitude-earthquake-jolts-caribbean-sea-area-tsunami-advisory-issued-2025-02-09-1111920>
- <https://www.aljazeera.com/news/2025/2/7/as-greece-declares-emergency-over-santorini-earthquakes-whats-next>
- <https://www.indiatv.in/world/asia/light-earthquake-hits-western-nepal-people-came-out-of-their-homes-2025-02-04-1110832>
- <https://www.bbc.com/news/articles/cp8qpn2p795o>

# VERTICAL GROUND MOTIONS AND ITS EFFECT ON STRUCTURES



**Dr. N. Subramanian**  
Ph.D., FNAE, F.ASCE

## ABSTRACT

Recent earthquakes have revealed that the vertical component of ground motion can exceed the horizontal component, especially in near-fault earthquakes, contradicting current code provisions, which assume that vertical ground motion is typically half to two-thirds of the horizontal component. After almost every major earthquake, engineers have attributed structural damage - such as buckling of bars at the base of large columns and failures of large-diameter reinforced concrete columns supporting buildings and freeway structures - to strong vertical ground motion. However, there is no clear consensus on the extent of damage caused by vertical motions. However, lessons from past earthquakes, including Loma Prieta, Northridge, and Kobe, have demonstrated that vertical excitation may increase the axial force, moment and shear demand, intensify plastic deformation, increase the plastic hinge formation, and reduce the ductile capacity of structural elements. Thus, it is clear that ignoring the vertical component in seismic design may lead to failures, especially for structures located near fault lines.

## INTRODUCTION

When an earthquake occurs, seismic waves radiate away from the source (epicenter) and travel rapidly through the earth's crust. When the waves reach the ground surface, they shake the building structures that may last from seconds to a few minutes. The strength

and duration of shaking at a particular site depends on the magnitude and location of the earthquake and on the characteristics of the soil at the site. At sites very close to the source of a large earthquake, the ground shaking can cause tremendous damage. The effect of soil on earthquake ground motion is significant, as it can either attenuate (reduce)-in the case of hard rocks or cohesive soils with high moisture content- or amplify seismic waves-in the case of soft loose, or water-saturated soils, with a natural frequency close to that of seismic waves. The behavior of seismic waves in soil is influenced by factors such as soil type, stiffness, layering and water content (Kramer, 1996). Hence, proper geotechnical investigations are essential for designing earthquake-resistant structures in high-risk areas.

When an earthquake occurs, different types of seismic waves are produced and categorized as body waves and surface waves, the latter occurs near the earth's surface only. Body waves are of two types: Primary waves (P-waves) and Secondary waves (S-waves), and surface waves that consist of Love waves and Rayleigh waves. P-waves are the fastest, followed in sequence by S-, Love and Rayleigh waves. S-waves, in association with surface waves (especially Rayleigh waves), cause maximum damage to structures due to their combined effects of lateral shearing and rocking motion, resulting in both vertical and horizontal displacements. It has to be noted that the shaking is more severe at the surface, and hence, underground structures are typically designed for smaller acceleration values due to reduced seismic amplification and wave trapping. However, factors such as soil type, depth, and fault proximity can still influence underground motion, so site-specific seismic studies are necessary for safer design (Kramer, 1996). During an earthquake, ground acceleration occurs and is measured in three directions: vertically (V or UD, for up-down) and two perpendicular horizontal directions

(H1 and H2), often north-south (NS) and east-west (EW). The peak acceleration in each of these directions is recorded, and the highest individual value is often reported. In seismic engineering, the term effective peak acceleration (EPA, the maximum ground acceleration to which a building responds) is often used, which tends to be  $\frac{2}{3}$  -  $\frac{3}{4}$  the PGA (peak ground acceleration).

From the above discussions, it is clear that engineering structures are subjected to earthquake ground motions in two horizontal and the vertical directions. However, traditionally seismic design is concerned with the horizontal components, neglecting the vertical component in both design and hazard assessments. Till 1976, most seismic design codes only considered the horizontal component of earthquake motion, assuming that the vertical component was insignificant. However, observations from destructive earthquakes, such as the 1971 San Fernando, 1989 Loma Prieta, 1994 Northridge, 1995 Kobe, and 1999 Chi-Chi earthquakes, indicated that vertical ground motion can be equal to or even significantly exceed the local horizontal ground motions.

### DAMAGES DUE TO VERTICAL COMPONENT OF EARTHQUAKES

The vertical component of earthquake ground motion, while is often less energetic than horizontal shaking, can still cause significant damage, particularly to structures like bridges and masonry buildings, leading to brittle failures,

“When an earthquake occurs, different types of seismic waves are produced and categorized as body waves and surface waves, the latter occurs near the earth’s surface only.”

increased axial forces and even collapse. These failures are briefly explained below:

- **Brittle Failures and Reduced Ductility:**

The vertical component can cause brittle failures in reinforced concrete columns and piers, reducing their ductility and ability to withstand deformation.

- **Increased Axial Forces:**

Vertical motions can lead to a significant increase in axial forces in structural members, especially in columns, which can lead to failure.

- **Damage to Bridge Piers and Decks:**

In bridges, the vertical component can cause pounding and vertical separation of girders from bearings, as well as damage to decks.

- **Collapse of Underground Structures:**

The vertical component can lead to a significant rise in axial forces in the central columns and even the collapse of underground structures.

- **Failure of Masonry Structures:**

Vertical ground motions can cause severe damage to low-strength masonry structures, potentially leading to their collapse.

- **Increased Vertical Acceleration Demands:**

The vertical component can change structural collapse mechanisms and increase vertical acceleration demands on columns and beam deformation demands.

- **Damage to Non-Structural Components:**

Earthquake-induced damage isn’t limited to structural elements, but can also include non-structural components like ceilings, electrical systems, furniture, and architectural partitions.

- **Premature Structural Deterioration:**

The vertical component can contribute to premature structural deterioration and accelerate failure mechanisms.

- **Importance of Accurate Modeling:**

Accurate modeling of vertical seismic accelerations is crucial in bridge design evaluations, as their impact on structural response and failure mechanisms cannot be underestimated.

- **Near-Field Effects:**

The vertical ground motion attenuates more rapidly than the horizontal one, so its effects are more intensive in near-field earthquakes.

Several researchers have highlighted the importance of considering the vertical component of earthquakes in the design, and quantified the damaging potential of the vertical component of ground motion (e.g. Papazoglou and Elnashai, 1996 and Bozorgnia, et al., 1999). Many observed failures of reinforced concrete columns were attributed to the reduction in shear strength caused by vertical ground motion effects. Kunnath et al. (2008) showed that vertical motion may magnify and potentially create reversal of

- Connection failures, especially in steel structures.

For instance, during the 2011 Christchurch earthquake, failures such as steel connection fractures and shear failure of concrete columns were attributed to reduced shear capacity under vertical tension forces (Dana et al., 2014). Similarly, the 1995 EERI report on the 1994 Northridge Earthquake noted brittle failures caused by direct vertical compression or by variations in axial forces that reduced shear strength and ductility (Collier and Elnashai, 2001).



Fig. 1: Damage to structures caused by the vertical component of earthquakes

bending moment in longitudinal bridge girders. Widespread phenomenon of bearing failure and deck unseating, as observed during several earthquakes, were partly attributed to the impact of vertical motions. Due to the studies by several researchers, it was determined that the vertical shaking may escalate the axial force in columns, cause an increase in the moment and shear demand, amplify plastic deformation, extend plastic hinge formation and also diminish the ductility capacity of structural component (Shrestha, 2009).

Numerous case studies have highlighted the pronounced effects of vertical ground motion, particularly when vertical and horizontal peak accelerations coincide, as is often observed near active faults, where P-waves and S-waves may arrive simultaneously (Dana et al., 2014).

The damaging effects of high vertical accelerations have been well documented. Potential failure modes include (see also Fig.1):

- Compressive and tensile failure of columns and walls
- Shear failure in beams and columns

## CODE PROVISIONS FOR VERTICAL MOTION OF EARTHQUAKE

Recorded seismic events have shown that vertical shaking can be substantial, sometimes exceeding horizontal accelerations, yet this phenomenon is not adequately addressed in current code-based designs. In order to include the vertical ground motion effects in design, recent efforts are concerned with the development of vertical ground motion spectra by focusing on near-fault accelerograms (e.g. Elnashai and Papazoglou, 1997; Bozorgnia and Campbell, 2004). These studies have developed vertical ground motion spectra and its parallel use with the horizontal ground motion spectra.

The first time a building code incorporated the vertical component of earthquake ground motion was in the 1976 Uniform Building Code (UBC) in the United States, which required critical infrastructure to consider vertical motion effects. The 1988 and 1997 UBC expanded vertical seismic load provisions, specifying multipliers (0.5 to 0.75 of horizontal ground motion) for design calculations.

Advanced research and data from earthquakes like Loma Prieta (1989), Northridge (1994) and Kobe (1995) led to further refinements. Today, most seismic codes globally (e.g., Eurocode 8, ASCE 7-22, IS 1893:2016) incorporate vertical acceleration, especially for near-fault structures, bridges and critical facilities.

As per clause 11.9 of ASCE 7-16, structures in seismic design category (SDC) C, D, E and F must also be designed for the effects of vertical shaking. All members in these SDCs must be designed for vertical seismic forces, whether or not they are part of the designated seismic force resistant system (SFRS). Vertical seismic load effect,  $E_v$ , can be determined from either of two equations:

$$E_v = 0.2S_{DS} D \quad (8-7)$$

$$E_v = 0.3S_{av} D \quad (8-8)$$

In the equation,  $S_{DS}$  is the horizontal design spectral acceleration at short periods and  $S_{av}$  is the vertical spectral response acceleration at short period, derived as per Section 11.9.2 of ASCE/SEI 7, and  $D$  is the dead load. Clause 11.9.2 of ASCE 7-22 gives several equations for developing the vertical response spectral acceleration,  $S_{amv}$ . It also states that in lieu of using the above procedure, a site-specific study can be performed to obtain  $S_{amv}$ , but the value so determined should not be less than 80% of the  $S_{amv}$  value determined from Equations provided in Clause 11.9.2 of ASCE 7-22.

It has to be noted that the predominant period in vertical spectrum takes place earlier than horizontal spectrum. Clause 3.2.2.3 of the Eurocode 8:2003 provides equations for

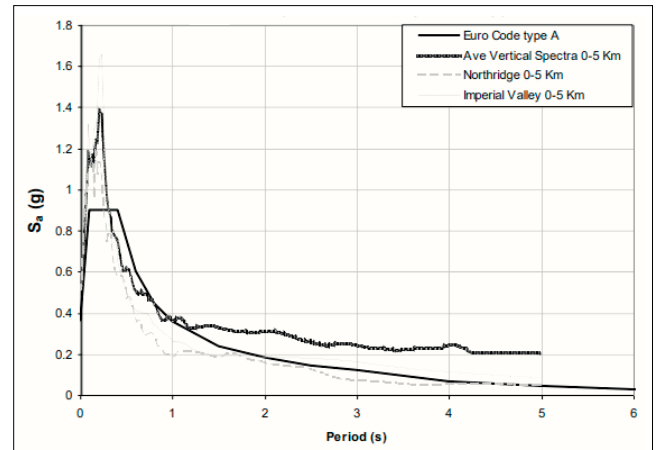

Fig. 2: Eurocode8’s vertical spectrum versus vertical average spectrum in < 5 km (Memarpour et al., 2016)

an elastic response spectrum,  $S_{ve}(T)$  for the vertical component of the seismic action. Despite the time coincidence of predominant periods in Eurocode-8’s vertical spectrum and the average, there is a considerable difference between the levels of acceleration within near-field regions, so that the level of acceleration in average spectrum is significantly higher than the level in Eurocode8’s spectrum, as seen in Fig.2.

Clause 6.4.6 of IS 1893 (Part 1): 2016 gives different equations for the design seismic acceleration spectral value  $A_v$  for vertical motions for buildings, liquid retaining tanks, bridges and industrial structures, which are essentially  $2/3^{rd}$  the value provided for horizontal acceleration.

### VERTICAL COMPONENT OF GROUND MOTION AND V/H RATIO

A common perception among engineers is that the vertical component of the ground motion is lower than the horizontal component, and hence the V/H ratio (ratio of vertical to horizontal peak ground acceleration) is assumed to remain less than the unity. As mentioned earlier, many codes, such as IS 1893-Part 1:2016 (Clause 6.4.6) suggest the scaling of the spectral shape of the horizontal component, as originally proposed by Newmark et al.(1973), by using an average V/H ratio of  $2/3$ . This suggestion results in all components of motion having the same frequency content. However, the frequency content in actual cases is demonstrably different. Also, the predominant period in

**“ In order to include the vertical ground motion effects in design, recent efforts are concerned with the development of vertical ground motion spectra by focusing on near-fault accelerograms. ”**



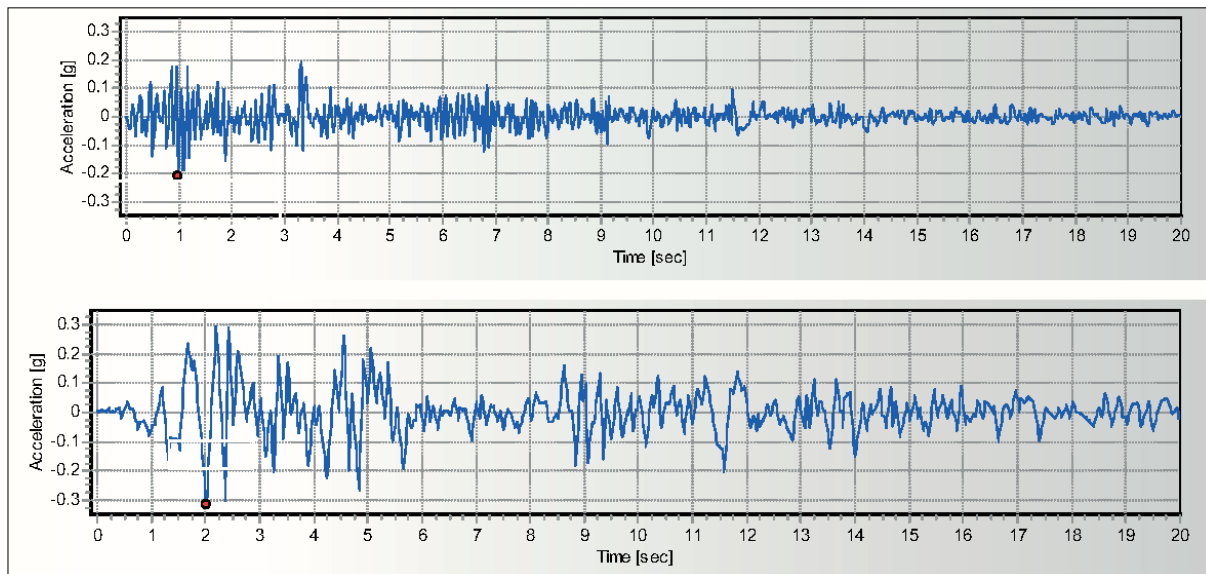

Fig. 3: Difference in frequency content of vertical (0.21g) and horizontal (0.32g) components of ground motion record as measured during the El Centro earthquake, 1940 (Ghosh and Gupta, 2018)

vertical spectrum takes place earlier than horizontal spectrum, for example, as shown in the 1940 El Centro earthquake, USA.

Several studies have found that the vertical-to-horizontal (V/H) ratio is strongly dependent on period, with short periods exhibiting higher ratios than long periods. This trend aligns with the observed differences in spectral shapes between the vertical and horizontal components of ground motion (Nayak, 2021).

- Maximum V/H Ratios: Occur at periods of 0.05–0.1 seconds.
- Minimum V/H Ratios: Found at periods of 0.4–0.8 seconds.
- Longer Periods: V/H gradually increases with period.

The V/H ratio depends on the earthquake magnitude and on the epicenter distance. Studies indicate that V/H is less influenced by magnitude, distance, and local site conditions than either the horizontal or vertical components individually. Table 1 shows significant V/H ratios observed in some past landmark earthquakes. It has to be noted that these values given in this table are specific to the particular measuring station of these earthquakes.

The V/H ratio was confirmed to be  $> 1.0$  within a 5 km radius of earthquake source,  $> 2/3$  within 25 km radius and dependent on earthquake magnitude from studies by Collier and Elnashai (2001).

**Table 1 Observed V/H Ratio in some past earthquakes (Shrestha, 2009 and Nayak, 2021)**

Name of earthquake	Magnitude - Richter scale	Horz.1 PGA (g)	Horz.2 PGA (g)	Vert. PGA(g)	V/H ratio
Gazli, Uzbekistan, 1976	6.8	0.71	0.63	1.34	1.89
Imperial Valley, El Centro, Southern California, USA, 1979	6.5	0.41	0.44	1.66	3.77
Nahanni, Canada, 1985	6.8	0.98	1.10	2.09	1.90
Morgan hill, USA, 1984	6.2	0.11	0.19	0.43	2.25
Loma Prieta, California, USA, 1989	7.1	0.56	0.61	0.89	1.47
Northridge, California, USA, 1994	6.7	0.84	0.47	0.85	1.02
Kobe, Japan, 1995	7.2	0.31	0.28	0.56	1.79
Chi Chi, Taiwan, 1999	6.3	0.11	0.12	0.26	2.07
Bhuj, Gujarat, India	6.9	0.34	0.38	0.38	1.0

Research on near-source recordings (Bozorgnia et al., 1995; 1996) found that:

- At short periods and short distances, V/H generally exceeds unity and can reach values as high as 1.8, especially on soil rather than rock.
- At long periods, V/H is typically below 0.5, particularly near the trough in the V/H spectrum, and tends to be higher on rock than on soil.

These findings highlight the importance of period-dependent effects when considering vertical seismic motion in structural design. Thus, the factor of 2/3 adopted in the codes, underestimates the effects of vertical motion at short periods and overestimates the effects at long periods, as seen in Fig. 4.

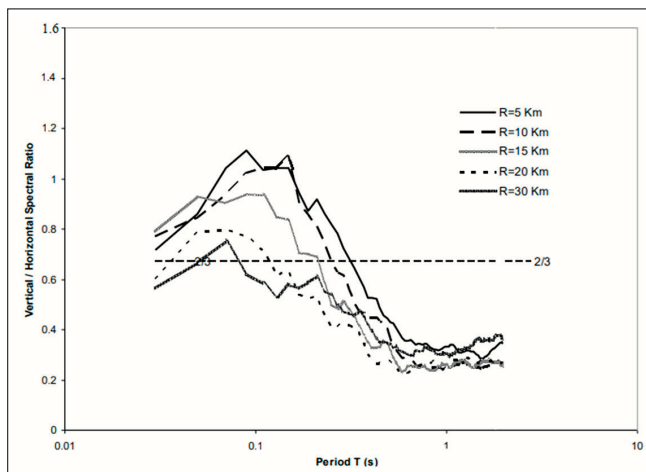

Fig. 4: V/H spectral ratio for Northridge, Imperial Valley, Chi-Chi, Duzçe, and Kocaeli earthquakes at different epicentre distances of R (Memarpour et al., 2016)

### CHARACTERISTICS OF THE VERTICAL COMPONENT OF GROUND MOTION

Vertical ground shaking primarily results from seismic compression waves (P-waves), while the horizontal components of ground motion are generated by seismic shear waves (S-waves) (Collier and Elnashai, 2001). These two components differ not only in directionality but also in their frequency content. Studies of past earthquakes have shown that the vertical component of ground motion typically contains higher frequency content than the horizontal component (See also Fig.3). Vertical accelerations tend to be strongest in the short-period range and

are generally confined to a narrow band of high frequencies (Elnashai and Papazoglou, 1997).

The most significant effects of vertical ground motion are observed during high-intensity, large-magnitude earthquakes, especially in near-fault regions. In such cases, vertical accelerations can exceed horizontal accelerations, sometimes by a considerable margin (Elnashai and Papazoglou, 1997). Given the differences in magnitude and frequency between peak vertical and horizontal spectral accelerations, the common practice of applying a linear scaling of vertical acceleration from the horizontal design spectrum, as found in current seismic codes, may lead to inaccurate estimations of structural demands. This highlights the need for a more nuanced and period-sensitive approach to incorporating vertical seismic effects in design.

### EFFECT OF VERTICAL COMPONENT OF EARTHQUAKES ON STRUCTURES

Structural and non-structural components of buildings typically exhibit short vertical periods, which correspond to the high-frequency content of vertical ground accelerations. Additionally, buildings tend to have lower damping and energy dissipation in the vertical direction (Elnashai and Papazoglou, 1997). These characteristics make vertical accelerations a concern across all building types, as vertical frequencies and damping are relatively independent of building height and lateral stiffness. Structural and non-structural components of buildings typically exhibit short vertical periods, which may correspond to the high-frequency content of vertical ground accelerations, leading to resonance and failure. Additionally, buildings tend to have lower damping and energy dissipation in the vertical direction (Elnashai and Papazoglou, 1997). As against the 2% to 5% of critical damping, which is commonly used in seismic design in the horizontal direction, the vertical direction damping is often around 1% to 2% of critical damping. These characteristics make vertical accelerations a concern across all building types, as vertical frequencies and damping are

relatively independent of building height and lateral stiffness.

Recent studies (Harrington and Abbie, 2016; Tzortzis et al., 2018; Vamvatsikos and Zeris, 2008) further confirm that the impacts of vertical ground motion vary significantly based on:

- Structural system,
- Material type,
- Building mass and load distribution,
- Construction practices, and
- Era of construction.

These findings underscore the need for more comprehensive seismic design provisions that explicitly address vertical ground motion, particularly in near-fault and high-seismicity regions.

Based on their a comparative study of the inelastic seismic performance of a six-storey RC building under the effect of both the horizontal and vertical components, Elfeki and Youssef (2007) found that by including the vertical component the building has resulted in extensive local damage (yielding of the reinforcing bars and crushing of the concrete). Tzortzis et al. (2016) conducted a non-linear time history analyses using LS-DYNA software on a 3-story steel moment frame structure under vertical and horizontal accelerations (with an SDS of 1.16 g and 1.2 g respectively) and found that the maximum drift ratios increased by about 5% for tri-directional motion, the floor slab accelerations were amplified significantly, up to 3.0g, the column axial demands were amplified up to 1.30 in

““ **A study of reinforced concrete columns modeled for the 2009 L’Aquila Italy earthquake experienced an amplification of compressive loads between 59% and 174%.** ””

““ **The vertical component of an earthquake can significantly alter structural response, potentially leading to increased axial forces.** ””

moment frame columns and up to 1.88 in gravity columns. In comparison, a study of reinforced concrete columns modeled for the 2009 L’Aquila Italy earthquake experienced an amplification of compressive loads between 59% and 174% (Di Sarno et al., 2011). Since the bottom flange of gravity beams were typically unbraced, the failure mode for these would be by lateral-torsional buckling.

Thus, the vertical component of an earthquake can significantly alter structural response, potentially leading to increased axial forces, especially in vertical elements (like columns and walls), changed the failure modes (like shear failure), and amplified demands on structural elements like columns and piers, especially in masonry structures. These are briefly explained below:

- **Increased Axial Forces:**

Vertical ground motion can lead to a rise in axial forces, particularly in central columns and underground structures, potentially causing compressive overstress or tension failure.

- **Changes in Failure Modes:**

The vertical component can induce diagonal shear failures in piers, modify failure modes and collapse mechanisms of reinforced concrete columns and even alter the development of cracks within structural elements.

- **Amplification of Demands:**

The vertical component can amplify demands on structural elements, such as bending moments and shear forces, leading to increased crack width and potentially changing crack patterns from bending to diagonal shear cracking.

• **Impact on Masonry Structures:**

Research indicates that the vertical component of earthquakes can increase nonlinear vertical displacement and the demand/capacity ratio in masonry structures.

• **Importance of Vertical Component in Near-Fault Earthquakes:**

Vertical earthquake ground motion, especially in earthquakes near the causative fault, can have a detrimental impact on the structural behavior of different systems.

• **Neglecting Vertical Component Can Lead to Biases:**

Neglecting the vertical component hazard consistency may result in significant biases in estimating the response dispersion of structures, especially those significantly influenced by the vertical component.

**SUMMARY AND CONCLUSIONS**

Engineering structures are subjected to earthquake ground motions in two horizontal and the vertical directions. However, traditionally seismic design is concerned with the horizontal components, neglecting the vertical component in both design and hazard assessments. However, observations from destructive earthquakes, such as the 1994 Northridge and the 1995 Kobe Earthquakes, indicated that vertical ground motion can be equal to or even significantly exceed the local horizontal ground motions. The vertical component of earthquake ground motion, along with the horizontal shaking, has been observed to result in significant damage to non-structural components and also building structures and bridges, due to brittle failures, increased axial forces, and even collapse. Only after 1976, building code incorporated the vertical component of earthquake ground motion in the building codes. Many codes, such as IS 1893-Part 1:2016(Clause 6.4.6) suggest the scaling of the spectral shape of the horizontal component, as originally proposed by Newmark et al.(1973), by using an average V/H ratio of 2/3. But in near-fault earthquakes the value of V/H ratio has been observed to be more than 2. The vertical component of an earthquake has also been found to significantly alter structural response,

potentially leading to increased axial forces, especially in vertical elements (like columns and walls), changed the failure modes (like shear failure) and amplified demands on structural elements like columns and piers. Hence, recent efforts are concerned with the development of vertical ground motion spectra. Such vertical component spectra are now prescribed by the Eurocode 8:2003 and ASCE 7-2022.

**REFERENCES**

1. Memarpour, M.M., Amiri, G.G., Razeghi, H., Akbarzadeh, M. and Davoudi, A.T. (2016). "Characteristics of Horizontal and Vertical Near-Field Ground Motions and Investigation of Their Effects on the Dynamic Response of Bridges", Journal of Rehabilitation in Civil Engineering, Vol.4, No.2, pp.1-24.
2. Bozorgnia, Y., Campbell, K. W. (2004). "The Vertical-to-Horizontal Response Spectral Ratio and Tentative Procedures for Developing Simplified V/H and Vertical Design Spectra", Journal of Earthquake Engineering, Vol. 8, No. 2, pp. 175-207.
3. Bozorgnia, Y., Campbell, K. W. and Niazi, M. (1999). "Vertical ground motion: Characteristics, relationship with horizontal component, and building-code implications," SMIP99 Seminar on Utilization of Strong-Motion Data; San Francisco; Proc., California Strong Motion Instrumentation Program, Sacramento, CA, pp. 23-33.
4. Bozorgnia, Y., Niazi, M. and Campbell, K. W. (1995) "Characteristics of free- field vertical ground motion during the Northridge earthquake," Earthquake Spectra, Vol. 11, pp. 515-525.
5. Bozorgnia, Y., Niazi, M. and Campbell, K. W. (1996) "Relationship between vertical and horizontal ground motion for the Northridge earthquake," Eleventh World Conference on Earthquake Engineering, Acapulco; Mexico, Proc.
6. Collier, C. J., and Elnashai, A. S. (2001). "A procedure for combining vertical and horizontal seismic action effects", Journal of Earthquake Engineering, Vol. 5, No.4,pp. 521-539.



7. Dana, M., Cussen, A., Chen, Y.N., Davis, C., Greer, M., Houston, J., Littler, P., and Roufegarinejad, A. (2014). "Effects of the seismic vertical component on structural behavior – An analytical study of current code practices and potential areas of improvement." Proceedings of the 10th National Conference in Earthquake Engineering, EERI, Anchorage, AK.
8. Di Sarno, L., Elnashai, A. S. and Manfredi, G. (2011). "Assessment of RC columns subjected to horizontal and vertical ground motions recorded during the 2009 L'Aquila (Italy) earthquake", Engineering Structures, Vol. 33, No.5), pp. 1514- 1535.
9. Elfeki, M.A. and Youssef, M.A. (2007). "Effect of the vertical earthquake component on the seismic response of reinforced concrete moment frames", 9th Canadian Conference on Earthquake Engineering, Ottawa, Ontario, Canada, 26-29 June.
10. Elnashai, A.S. and Papazoglou, A.J., (1997). "Procedure and Spectra for Analysis of RC Structures Subjected to Strong Vertical Earthquake Loads", Journal of Earthquake Engineering, Vol. 1, No. 1, pp. 121-156.
11. Eurocode 8(2003). Design of structures for earthquake resistance -Part 1: General rules, seismic actions and rules for buildings, prEN 1998-1, European Committee for Standardization, Brussels
12. Ghosh, S.K. and Gupta, P.D. (2018) "Explicit Considerations of Vertical Earthquake Ground motion in the Design of Structures", 3rd RN Raikar Memorial International Conference & 'Gettu-Kodur' International Symposium on Advances in Science & Technology of Concrete, Mumbai, India, pp.44-56.
13. Harrington, C. C., and Abbie B. L. (2016). "Collapse assessment of moment frame buildings, considering vertical ground shaking", Earthquake Engineering & Structural Dynamics, Vol. 45, No.15, pp. 2475-2493.
14. IS 1893-Part 1:2016. Criteria for Earthquake Resistant Design of Structures, (Sixth Revision), Bureau of Indian Standards, New Delhi, 44 pp.
15. Kramer, S.L. (1996) Geotechnical Earthquake Engineering, Prentice Hall, Inc., Upper Saddle River, N.J.
16. Kunnath, S.K., Abrahamson, N., Chai, Y.H., Erduran, E., and Yilmaz, Z., (2008). "Development of Guidelines for Incorporation of Vertical Ground Motion Effects in Seismic Design of Highway Bridges", Technical report CA/UCD-SESM-08-01, University of California at Davis.
17. Nayak, C. (2021) "A state-of-the-art review of vertical ground motion (VGM) characteristics, effects and provisions", Innovative Infrastructure Solutions, Vol.6, pp.124-142, DOI: 10.1007/s41062-021-00491-3
18. Newmark, N.M., Blume, J.A. and Kapur, K.K. (1973). "Seismic Design Spectra for Nuclear Power Plants", Journal of the Power Division, Proceedings of ASCE, Vol. 99, No.PO2, pp. 287–303.
19. Papazoglou, A.J. and Elnashai, A.S., (1996). "Analytical and Field Evidence of the Damaging Effect of Vertical earthquake Ground Motion", Earthquake Engineering and Structural Dynamics, Vol. 25, 1109-1137.
20. Shrestha, B. (2009) Vertical Ground Motions and its Effect on Engineering Structures: A State-of-the-Art Review, International Seminar on Hazard Management for Sustainable Development, Kathmandu, Nepal, Nov. 29-30.
21. Tzortzis, A., Paul, N., and Almufti, I. (2018). "Implications of the vertical component of ground motion on building response", Eleventh U.S. National Conference on Earthquake Engineering-Integrating Science, Engineering & Policy, June 25-29, Los Angeles, California
22. Vamvatsikos, D, and Zeris, C. (2008). "Influence of uncertain vertical loads and accelerations on the seismic performance of an RC building", 3<sup>rd</sup> Panhellenic Conference on Earthquake Engineering and Engineering Seismology, Athens.



Since 1983  
Dr. Vishwanath Karad  
**MIT WORLD PEACE UNIVERSITY** | PUNE  
TECHNOLOGY, RESEARCH, SOCIAL INNOVATION & PARTNERSHIPS



## Department of Civil Engineering

in association with



Warmly invite all students and faculty members organizing a one-day workshop with the industry-academia collaboration.

For One Day Workshop on

# "EARTHQUAKE ENGINEERING AND STRUCTURAL RETROFIT"

Chief patron

**Shri. Rahul V. Karad**

Executive President, MIT World Peace University



**Head**

Codes & Approval (Fastening) and Engineering Marketing  
Hilti India



**Managing Director**

Strudcom Consultants Pvt. Ltd.  
Proprietor  
JVI Prestressing Systems - Pune



**Managing Director**

Avenue Enterprise  
Structural Consultancy  
Pune

**Date: 21<sup>st</sup> January 2025**

The Workshop will focus on Seismic resistant design of structures, Seismic Safety of Non-Structural Elements and Retrofitting of structures. The aim of Workshop to make a comprehensive and give the students better industry exposure We look forward to your active participation and contribution to this workshop.

**Program Director**

Prof. Dr. Shantini A. Bokil

**Convener**

Prof. Dr. Sudhir P. Patil

**Co - Convener**

Prof. Dr. Sandhya R. Mathapati

**Organizing Team:**

Dr. Sandeep Sathe

Dr. Shahbaz Dandin,

Dr. Ganesh Ingle

Dr. Darshan Gaidhankar

Dr. Sumant Shinde

Dr. Ketaki Kulkarni

Dr. Lipsa Mishra

To know more, click

<https://theseismicacademy.com/workshop-detail/earthquake-engineering-and-structural-retrofit>

## WORKSHOP ON EARTHQUAKE ENGINEERING AND STRUCTURAL RETROFIT

A one-day workshop on “**Earthquake Engineering And Structural Retrofit**” was conducted on 21<sup>st</sup> January 2025 at MIT World Peace University (WPU), Pune, under the aegis of the Seismic Academy. The workshop aimed to enhance understanding and knowledge in earthquake engineering and retrofitting strategies, among the students.

The workshop commenced with an engaging session by **Mr. Shounak Mitra**, Head - Codes & Approval and Engineering Marketing, M/s Hilti India Pvt. Ltd. He provided valuable insights into the significance of seismic design for non-structural elements, emphasizing the critical role they play in overall safety during earthquakes.

Following this, two insightful sessions on structural retrofit were delivered by industry veterans. **Mr. Jayant Inamdar**, **Managing Director, Strudcom Consultants Pvt. Ltd.**, and **Mr. Sushil Naghate**, **Managing Director, Avenue Enterprise Structural Consultancy**, shared their expertise on various retrofitting techniques and best practices to enhance the resilience of existing structures against seismic events.



# RECENT WORKSHOPS

**Dr. Mangesh Shendkar, Assistant Professor at the School of Civil Engineering, MIT-WPU,** presented an in-depth deliberation on **“Seismic Evaluation and Retrofit of Reinforced Concrete Buildings in Severe Earthquake Prone Areas.”** His session provided a detailed analysis of structural vulnerabilities and methodologies for strengthening buildings to withstand seismic forces effectively.

The workshop concluded with an interactive Q&A session, where participants had the opportunity to clarify their doubts and discuss practical applications of seismic engineering concepts. The event received an overwhelming response and provided a valuable platform for knowledge exchange for the students.



## SEISMIC RESILIENCE FOR HEALTHCARE FACILITIES

Deep dive with us to understand how to create resilient healthcare facilities

### SPEAKER

**Dr. Saurabh Dalal**  
NPO (Emergency Preparedness and Risk Management)  
World Health Emergencies (WHE) Team  
WHO India

### SPEAKER

**Dr. George Joseph Kodickal**  
Health Emergencies and Disaster Risks Management Officer  
World Health Emergencies (WHE) Team  
WHO India

**27<sup>th</sup> February 2025, Thursday**  
**Time: 3:00 PM - 4:00 PM (IST)**

[Know More >](#)

<https://theseismicacademy.com/webinar-detail/seismic-resilience-for-healthcare-facilities>

We all know that India is located in a seismically active zone, and not all buildings are constructed following best practices for earthquake-resistant design. In this context, it becomes imperative to prioritize making healthcare facilities earthquake-resilient to ensure maximum safety and well-being during emergency scenarios.

With the ever-evolving nature of construction, it is high time we understand its essence and work collectively towards creating a safer built environment.

To help gain this knowledge, we bring you an exclusive webinar with some of our industry experts. They will share actionable strategies to make hospitals seismic resilient for safeguarding lives when it matters most.

To help gain this knowledge, we organized an exclusive webinar with some of our industry experts. They shared actionable strategies to make hospitals seismic resilient for safeguarding lives when it matters most.



# TOKYO SKYTREE

## A MODERN MARVEL IN THE HEART OF TOKYO



### INTRODUCTION

May 2012 saw the completion of the world's second tallest structure, the Tokyo Sky Tree television transmitter and observation tower. Standing at 634 meters, the tower is an audacious technological feat, considering this is at the heart of an earthquake zone. There are observation facilities at heights of 350 meters and 450 meters. Above 500 meters, there is a gain tower, which is installation space for TV antennae. In addition to the tower itself, offices and commercial facilities, a planetarium, an art gallery are included, covering a total area of 230,000 square meters. Designed by Nikken Sekkei Ltd., Tokyo Sky Tree contributes to the revitalization of eastern Tokyo. The engineers ensured blending contemporary aesthetics with traditional Japanese beauty alongside becoming a catalyst for city renewal as well as assisting in disaster preparedness



## THE INITIAL CHALLENGES

To provide the desired height-to-base ratio to ensure the structure is intrinsically more stable, the Sky Tree needed to be 181 meters wide at its base. However, the site did not offer this sort of space and had the provision only for a square structure 60 meters wide at its base. A circular shape would be limited to the same 60 meters for its diameter at ground level. The designers eventually proposed an extra 8 meters of support width out of the site by opting for a triangular base 68 meters on a side. The tower's cross-section changes from triangular to circular form while it ascends, therefore improving its structural integrity.

The designers also had to better understand conditions at an altitude above 600 meters and to do that they floated a weather balloon to gather extensive wind data - wind data used to fathom the lateral wind forces that the building would have to withstand. Meanwhile, the company undertook a "micro-motion array observation" granting insight in the minutest detail of the make-up of the earth to a depth of 3 km underground. This level of detailing allowed much more accurate computer simulation of building sway in earthquake conditions.

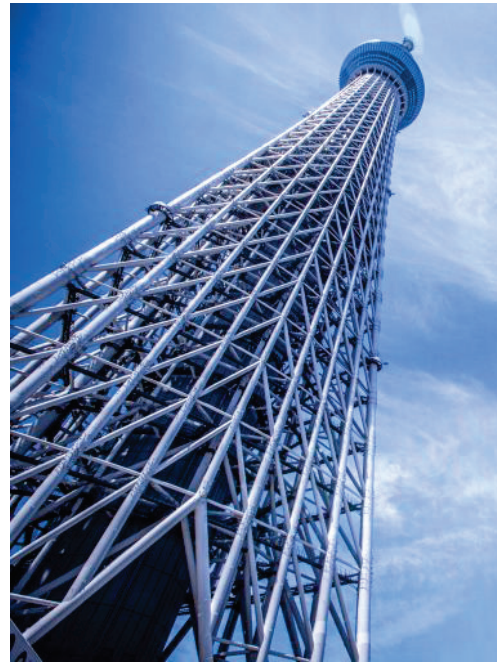

## STRUCTURAL DESIGN & EARTHQUAKE RESILIENCE

### TRIANGULAR TRUSS STRUCTURE

A distinctive design quality of the Tokyo Skytree involves its changing cross-section structure that possesses fundamental characteristics for protecting against seismic events. The base section of the tower consists of three equal-length sides, 68 meters each. The triangular base establishes a solid base to direct seismic forces across a wide area. The principle of load distribution comes to play as the triangular shape distributes forces across a wider area therefore lowering stress points. The structural efficiency of resisting torsional forces by circular cross-sections exceeds other cross-sectional shapes according to the laws of geometric stiffness.

The Sky Tree's structural design relies on extremely strong steel tubes which, at the tower's base, have a diameter of 2.3 meters and a thickness of 100 millimetres. These are arranged in an array of triangular trusses that extends vertically and diagonally and horizontally to form triangular shapes. Engineers calculated the design parameters to create this structure which provides flexibility during tower movements triggered by earthquakes and typhoons. The structure incorporates high-strength steel pipes which represent steel components that demonstrate double the strength of typical steel frame materials.



### RESPONSE CONTROL SYSTEM WITH CORE COLUMN

This inherent strength is thought to stem from the fact that the central column acts as a counterweight about which the rest of the building's structure can vibrate. Nikken Sekkei brought the concept up to date with centre column vibration control, with the core column and surrounding steel frame

connected by a flexible oil damper. At the centre of the tower stands a 375-meter steel-reinforced cylinder, fully 8 meters across and weighing 11,000 metric tons. The bottom third of this cylinder — up to 125 meters — is fixed solidly to the surrounding structure. In its upper two-thirds, meanwhile, up to 125 meters — is fixed solidly to the surrounding structure. In its upper two-thirds, meanwhile, up to its full height of 375 meters, it is not welded to the tower. The unattached portion of the core can swing freely, its movement absorbed by oil dampers between it and the surrounding beams. When an earthquake brings horizontal shaking, the core sways at a different frequency from that of the tower, counteracting the shaking and bringing the structure back to a stable state. This construction can reduce lateral motion by up to 50%. The bottommost part of the central pillar is supported by six anti-seismic bearings that are 1.4 meters in diameter. This prevents the pillar from coming into direct contact with the ground.

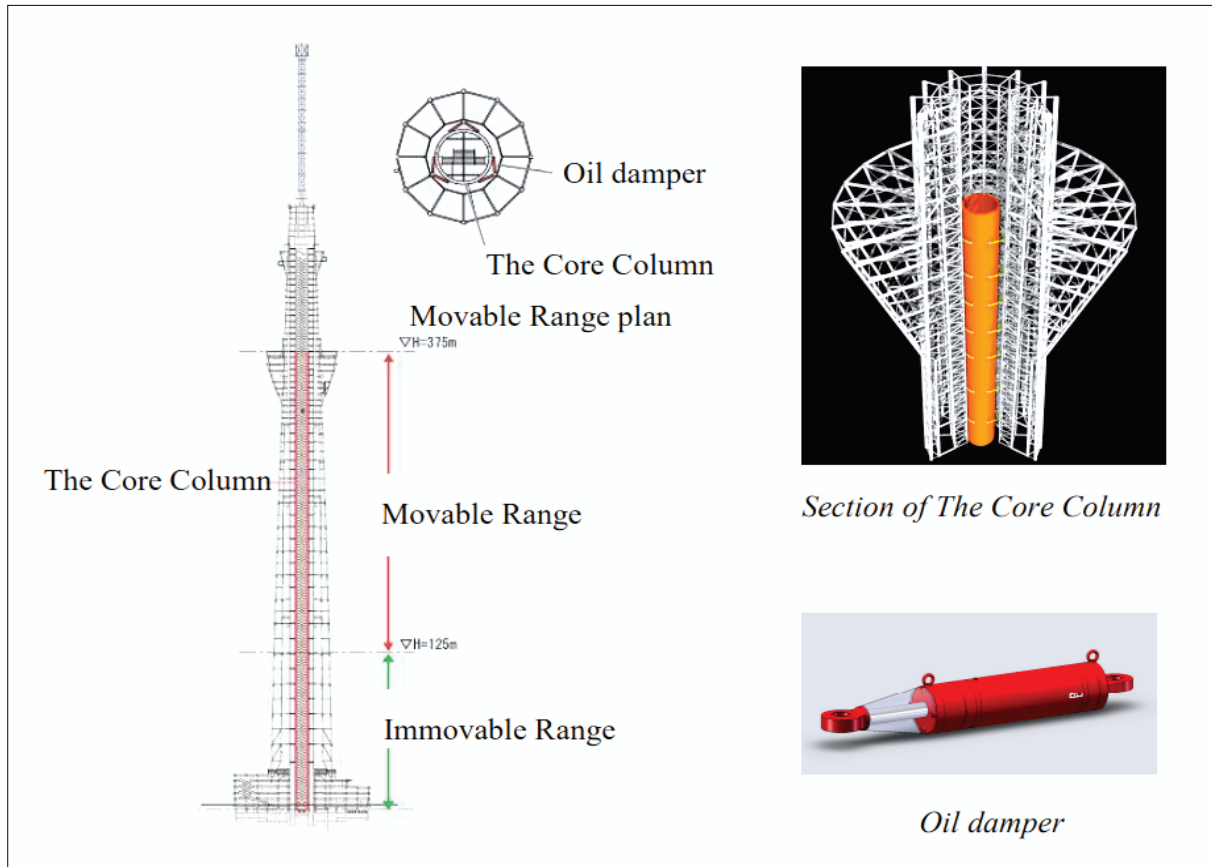

### DAMPING SYSTEM

Additional resilience is achieved through an “added mass control mechanism” (or tuned mass damper) - a damping system which, in the event of an earthquake, moves out of step with the building’s structure, to keep the centre of gravity as central as possible to the tower’s base. The oil damper functions as a protective element that stops the core column from striking the tower body during shaking movements. The design utilizes damping principles to minimize mechanical vibrations through its implementation.



The Tokyo Skytree uses an advanced damping system which improves its ability to resist seismic events. The core column system employs the core shaft emergency staircase reinforced concrete

tube wall as a weight to implement Tuned Mass Dampers (TMD) theory. The implemented system achieves earthquake acceleration reduction of 50% and wind acceleration reduction of 30% through its effective operation.

The tower maintains two Tuned Mass Dampers (TMD) systems at its peak to regulate wind response and protect broadcasting reliability. The upper TMD system carries 25 tons of weight while the lower TMD system weighs 40 tons. The installed systems decrease the building's velocity response to both daily wind forces and seismic

movements. The TMDs function through dynamic vibration absorption by oscillating at opposite phases to building motions to decrease vibration intensity.

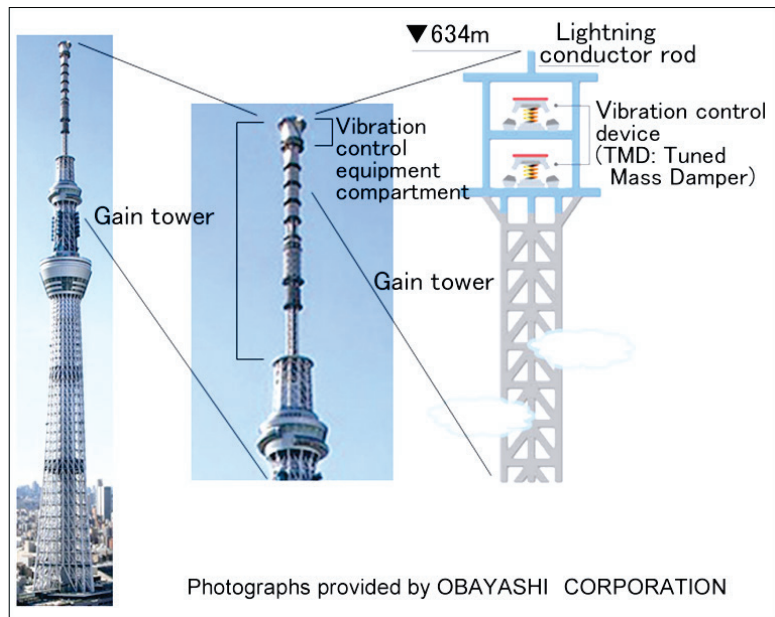

## FOUNDATION DETAILS AND GEOMETRY

This level of resilience is nothing without the proper foundation, and the Sky Tree's foundation gives the buildings its name. The Tokyo Skytree foundation has been engineered to deliver both high horizontal stiffness and uplift force resistance. The Tokyo Skytree stands at the Sumida River banks where the surface layer presents soft conditions. Beneath each of the tower's three legs is a cluster of 50 meters deep walled piles with steel-reinforced concrete nodes, which Nikken Sekkei compares to the root system of a gigantic tree, "monolithically integrated" with the ground. The wall piles follow a petal arrangement which connects the tower structure to the ground foundation. The foundation features the Kanae Pile as Steel Reinforced Concrete continuous underground wall pile that uses rigid soil substrate weight to counteract massive uplift forces. The stability of the Kanae Pile was confirmed through an extensive on-site pull-out test which achieved 40,000 kN of maximum load. The foundation design implements soil-structure interaction principles to achieve load resistance through combined soil and structure operation.

The foundation system of the Tokyo Skytree was specifically designed to handle the distinctive problems created by the tower's elevated position and great height. The foundation system needed to address the soft surface layer of the ground through a system that would deliver strong horizontal rigidity and resistance to uplift forces.

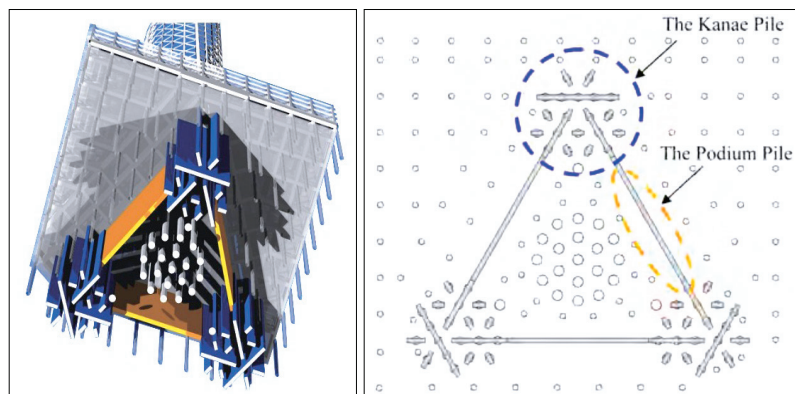

The continuous underground wall piles received selection because they could connect both the tower and the ground to form a stable foundation.

The Podium Pile demonstrates horizontal rigidity which minimizes foundation displacement when strong winds or large earthquakes occur. The construction method allowed the continuous underground wall piles to be built through consecutive pile hole excavation while maintaining

ground stability with stable liquid. The principle of soil stabilization enables this method to prevent excavation wall collapse using stable liquid.

The foundation of the tower experiences powerful uplift together with compression forces which result from winds and earthquakes and additional factors. The engineers developed “knuckle walls” which are wall-shaped piles featuring nodular protuberances. The nodules provide strong anchorage that enables piles to withstand greater loads in the ground. The rigid shape of knuckle walls enables them to resist horizontal seismic forces effectively. The foundations of ultra-tall buildings like Tokyo Sky Tree receive their strength from the robust knuckle walls.

The CWS joint served as a shearing force transmission system which efficiently linked foundation wall panels together. The foundation’s stability increases through shear transfer design which enables joints to transmit forces between neighbouring panels.

The Kanae Piles foundation walls received their construction from reinforced concrete that included steel frames and bars embedded within. Concrete pump vehicles distributed concrete through temporary stages to create concrete structures using tremie pipes at each panel.

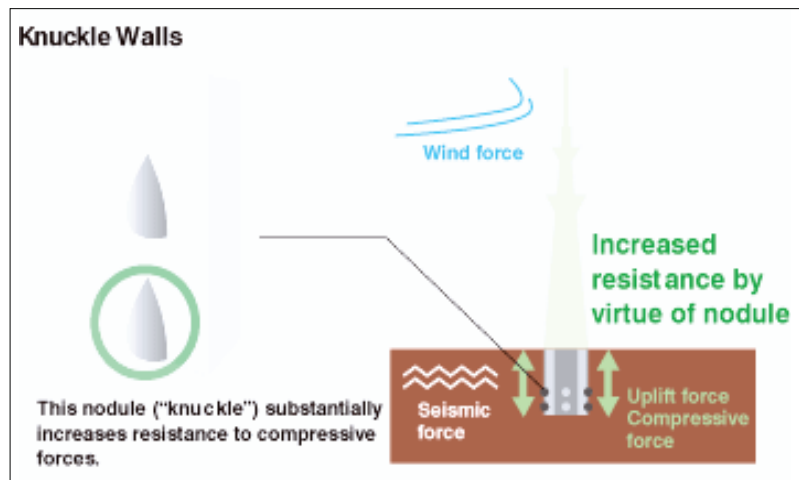

## CONCLUSION

The architectural style of Tokyo Sky Tree is modern and futuristic, with a design inspired by traditional Japanese structures such as pagodas and the ‘sorakazari’ decorative element used in Japanese shrines and temples. The tower’s sleek, tapering form and steel lattice structure are also reminiscent of Tokyo’s industrial past. With a strong blend of fine architecture and robust engineering, this continues to be one of the timeless seismic splendours of the world.

## REFERENCES

- [2624-structural-design-and-construction-of-the-foundation-of-tokyo-sky-tree.pdf](#)
- [249-259 01.Atsumo Konishi.fm](#)
- [876-structural-design-of-tokyo-sky-tree.pdf](#)
- [The Japanese Earthquake Resistance Technologies that Support TOKYO SKYTREE | TOKYO UPDATES \[The Official Information Website of Tokyo Metropolitan Government\] - https://www.tokyoupdates.metro.tokyo.lg.jp/en/post-1153/](#)
- [Secrets of the Sky Tree: Quake-proofing the world’s second tallest structure - https://newatlas.com/tokyo-sky-tree/21682/](#)
- [TOKYO SKYTREE Construction Project | OBAYASHI CORPORATION GLOBAL SITE - https://www.obayashi.co.jp/en/special/skytree.html](#)
- [Discovering Tokyo Skytree: A Modern Marvel in the Heart of Tokyo - https://www.japan-mobility.com/tokyo/skytree](#)
- <https://resources.matcha-jp.com/>
- [Tokyo Skytree: A Timeless Landmark | Nippon.com](#)
- [Secrets of the Sky Tree: Quake-proofing the world’s second tallest structure](#)



**CSIR-Central Building Research Institute**  
**Ministry of Science and Technology**  
**Roorkee, India**



**Join The Panel Discussion On**

# 'Ruins to Resilience'

*Lessons from the 2015 Nepal Earthquake for Rebuilding Public Infrastructure*

**Tuesday May 13, 2025, 10:30 AM-13:30 PM (IST)**

## Panelists



**Shri Krishna S. Vatsa,**  
Member, NDMA



**Prof. C.V.R. Murty**  
IIT Madras



**Prof. Y. Singh**  
IIT Roorkee



**Prof. D. Srinagesh**  
IIT Madras



**Prof. Rupen Goswami**  
IIT Madras



**Mr Arun Kumar**  
Director (NBC Unit) BIS.



**Mr. Jitendra Kumar**  
BIS



**Dr. Hari Kumar**  
GeoHazards International



**Mr. Anup Karanth**  
World Bank Group



**Ar. S. K. Negi**  
CSIR-CBRI Roorkee



**Dr. D. P Kanungo**  
CSIR-CBRI Roorkee

## Moderators



**Prof. R. Pradeep Kumar**  
Director CSIR-CBRI Roorkee



**Dr. Ajay Chourasia**  
CSIR-CBRI Roorkee

## About The Panel Discussion

In the aftermath of the devastating Twin Nepal earthquakes on April 25 and May 12, 2025, the widespread destruction of educational and healthcare facilities posed a critical challenge to the nation's recovery and future resilience. Recognizing the urgent need for safe and sustainable reconstruction, the CSIR-Central Building Research Institute (CBRI), Roorkee, under the aegis of Ministry of External Affairs, Govt. of India, New Delhi spearheaded a comprehensive initiative to support Nepal's efforts in rebuilding Education and Health Sectors with enhanced seismic safety standards. To commemorate 1st decade of the 2015 Nepal Earthquake, CSIR-CBRI is organizing a panel discussion. This panel discussion brings together experts, policymakers, engineers, and field practitioners to reflect on CBRI's decade-long initiative in rebuilding schools and hospitals in Nepal with a focus on seismic safety, sustainability, and community resilience.

The session will explore the entire spectrum of recovery—beginning with rapid damage assessment, followed by resilient design approaches, capacity building, and implementation of reconstruction

projects under challenging conditions. Panelists will also discuss the challenges encountered in cross-border collaboration, innovations in seismic design for public infrastructure, and long-term lessons learned that can inform future disaster recovery efforts in South Asia and beyond.

As the region marks a decade since the disaster, this session aims to reflect not only on the technical milestones achieved but also on the human and institutional capacities strengthened through collaborative reconstruction.

Scan QR



To Register

**Registration Link:** <https://forms.gle/xxo66L3Dig8gc4Rj9>

Registration is free, but prior registration is mandatory.



# BUILDING RETROFITS: BREATHING LIFE INTO EXISTING STRUCTURES

Seismic Academy Annual Conference 2025

**FOR MORE DETAILS, STAY TUNED**

- **Date - 17th October**
- **Venue - New Delhi**